

|   |             |   |             |
|---|-------------|---|-------------|
| <b>BOAT MAINTENANCE</b> .....                           | <b>2-37</b> | Idle Speed .....                        | 2-57        |
| BATTERIES .....   | 2-37        | Low Speed Setting .....                 | 2-56        |
| FIBERGLASS HULL .....                                   | 2-39        | 9.9/10/14/15 HP (216cc) & 9.9/10/15 HP  |             |
| <b>CLEARING A SUBMERGED MOTOR</b> .....                 | <b>2-83</b> | (255cc) 2-STROKE MODELS .....           | 2-57        |
| <b>GENERAL INFORMATION</b> .....                        | <b>2-2</b>  | Cam Follower Pickup Point .....         | 2-58        |
| BEFORE/AFTER EACH USE .....                             | 2-3         | Idle Speed .....                        | 2-59        |
| Visual Inspection .....                                 | 2-5         | Low Speed Mixture .....                 | 2-58        |
| ENGINE IDENTIFICATION .....                             | 2-2         | Preliminary Adjustments .....           | 2-58        |
| Engine Serial Numbers .....                             | 2-3         | Shift Lever Detent .....                | 2-59        |
| MAINTENANCE COVERAGE .....                              | 2-2         | Wide Open Throttle Stop .....           | 2-58        |
| MAINTENANCE EQUALS SAFETY .....                         | 2-2         | 9.9/15 HP (305cc) 4-STROKE MODELS ..... | 2-59        |
| OUTBOARDS ON SAIL BOATS .....                           | 2-2         | Idle Speed .....                        | 2-60        |
| <b>LUBRICATION SERVICE</b> .....                        | <b>2-6</b>  | Low Speed Setting .....                 | 2-60        |
| ELECTRIC STARTER MOTOR PINION .....                     | 2-6         | Shift Lever Detent .....                | 2-59        |
| ENGINE COVER LATCHES .....                              | 2-7         | 20 HP (521cc) MODELS .....              | 2-61        |
| ENGINE MOUNT CLAMP SCREWS .....                         | 2-7         | Cam Follower Pickup Point .....         | 2-61        |
| JET DRIVE BEARING .....                                 | 2-7         | Idle Speed .....                        | 2-62        |
| Recommended Lubricant .....                             | 2-7         | Initial Low Speed Setting .....         | 2-63        |
| Daily Bearing Lubrication .....                         | 2-7         | Maximum Spark Advance .....             | 2-62        |
| Grease Replacement .....                                | 2-7         | Throttle Control Rod (1990) .....       | 2-62        |
| POWER TRIM/TILT RESERVOIR .....                         | 2-8         | 18 JET & 25-35 HP (521cc) MODELS .....  | 2-63        |
| Fluid Level/Condition .....                             | 2-8         | Cam Follower Pickup Point .....         | 2-63        |
| Recommended Lubricant .....                             | 2-8         | Idle Speed .....                        | 2-64        |
| LINKAGE, CABLES AND SHAFTS .....                        | 2-8         | Initial Low Speed Setting .....         | 2-64        |
| STEERING .....  | 2-13        | Maximum Spark Advance .....             | 2-64        |
| SWIVEL BRACKET .....                                    | 2-14        | Throttle Control Rod .....              | 2-64        |
| TILT ASSEMBLY .....                                     | 2-14        | 25-55 HP (737cc) 2-CYL MODELS .....     | 2-65        |
| <b>ENGINE MAINTENANCE</b> .....                         | <b>2-15</b> | Cam Pickup Point .....                  | 2-66        |
| ANODES (ZINCS) .....                                    | 2-35        | Idle Speed .....                        | 2-67        |
| Inspection .....  | 2-35        | Initial Low Speed Setting .....         | 2-67        |
| Servicing .....   | 2-35        | Maximum Spark Advance .....             | 2-68        |
| COOLING SYSTEM .....                                    | 2-16        | Preliminary Adjustments .....           | 2-65        |
| Flushing .....  | 2-16        | Shift Lever Detent .....                | 2-69        |
| ENGINE COVERS .....                                     | 2-15        | Throttle Cable .....                    | 2-68        |
| Removal & Installation .....                            | 2-15        | Throttle Control Rod .....              | 2-68        |
| ENGINE OIL (2-STROKE) .....                             | 2-18        | Throttle Plate Synch .....              | 2-66        |
| Filling .....   | 2-19        | Wide Open Throttle Stop .....           | 2-68        |
| Recommendations .....                                   | 2-18        | 25/35 HP (500/565cc) 3-CYL .....        | 2-69        |
| ENGINE OIL/FILTER (4-STROKE) .....                      | 2-20        | Cam Follower Pickup .....               | 2-71        |
| Checking Oil Level .....                                | 2-20        | Idle Timing .....                       | 2-70        |
| Oil/Filter Change .....                                 | 2-21        | Initial Low Speed .....                 | 2-71        |
| Recommendations .....                                   | 2-20        | Maximum Spark Advance .....             | 2-71        |
| FUEL FILTER .....                                       | 2-25        | Neutral Detent .....                    | 2-71        |
| Carbureted Motors .....                                 | 2-26        | Preliminary Adjustments .....           | 2-69        |
| EFI Motors .....  | 2-28        | Timing Pointer .....                    | 2-70        |
| GEARCASE (LOWER UNIT) OIL .....                         | 2-23        | Throttle Plate Synch .....              | 2-70        |
| Checking .....  | 2-24        | Wide Open Throttle Positioning .....    | 2-71        |
| Draining & Filling .....                                | 2-25        | 25-70 HP (913cc) 3-CYL .....            | 2-72        |
| Recommendations .....                                   | 2-24        | Cam Follower Pickup .....               | 2-73        |
| JET DRIVE IMPELLER .....                                | 2-32        | Idle Timing .....                       | 2-74        |
| Checking .....  | 2-32        | Initial Low Speed Setting .....         | 2-75        |
| Inspection .....  | 2-32        | Maximum Spark Advance .....             | 2-75        |
| PROPELLER .....   | 2-29        | Shift Lever Detent .....                | 2-75        |
| Inspection .....  | 2-29        | Timing Pointer .....                    | 2-72        |
| Removal & Installation .....                            | 2-30        | Throttle Cam .....                      | 2-74        |
| RESCUEPRO ROTOR .....                                   | 2-33        | Throttle Cable .....                    | 2-73        |
| TIMING BELT .....                                       | 2-36        | Throttle Plate Synch .....              | 2-73        |
| Inspection .....  | 2-36        | Wide Open Throttle Stop .....           | 2-74        |
| <b>SPECIFICATIONS</b> .....                             | <b>2-85</b> | 40/50 HP 4-STROKE MODELS .....          | 2-76        |
| CAPACITIES - TWO-STROKE ENGINES .....                   | 2-90        | Idle Bypass Air Screw .....             | 2-76        |
| CAPACITIES - FOUR-STROKE ENGINES .....                  | 2-91        | Ignition Timing .....                   | 2-76        |
| GENERAL ENGINE .....                                    | 2-85        | Shift Linkage .....                     | 2-76        |
| GENERAL ENGINE SYSTEM .....                             | 2-87        | 70 HP 4-STROKE MODELS .....             | 2-77        |
| LUBRICATION SERVICES .....                              | 2-89        | Idle Bypass Air Screw .....             | 2-77        |
| MAGNETO BREAKER POINT GAP .....                         | 2-84        | Ignition Timing .....                   | 2-77        |
| MAINTENANCE INTERVALS .....                             | 2-89        | Shift Linkage .....                     | 2-77        |
| TUNE-UP SPECIFICATIONS .....                            | 2-91        | <b>TUNE-UP</b> .....                    | <b>2-40</b> |
| TWO-STROKE MOTOR FUEL:OIL RATIO .....                   | 2-90        | BREAKER POINTS IGNITION SYSTEMS .....   | 2-47        |
| VALVE CLEARANCE .....                                   | 2-94        | General Information .....               | 2-47        |
| <b>STORAGE</b> .....                                    | <b>2-81</b> | Inspection & Testing .....              | 2-47        |
| RE-COMMISSIONING .....                                  | 2-83        | Replacement .....                       | 2-48        |
| WINTERIZATION .....                                     | 2-81        | COMPRESSION TESTS .....                 | 2-41        |
| <b>TIMING AND SYNCHRONIZATION</b> .....                 | <b>2-51</b> | Leakage Check .....                     | 2-42        |
| HOMEMADE SYNCHRONIZATION TOOL .....                     | 2-52        | Tune-Up Check .....                     | 2-41        |
| 2.0-3.5 HP MODELS .....                                 | 2-53        | DE-CARBONING THE PISTONS .....          | 2-41        |
| Idle Speed .....  | 2-53        | ELECTRONIC (CDI/EFI) IGNITION .....     | 2-51        |
| 5 HP (109cc) MODELS .....                               | 2-53        | Inspection .....                        | 2-51        |
| Low Speed Mixture .....                                 | 2-53        | INTRODUCTION .....                      | 2-40        |
| COLT/JUNIOR, 3/4 HP & 4 DELUXE MODELS .....             | 2-53        | SPARK PLUGS .....                       | 2-43        |
| Camshaft Follower Pickup Point .....                    | 2-53        | Heat Range .....                        | 2-43        |
| Mixture Adjustments .....                               | 2-54        | Inspection & Gapping .....              | 2-46        |
| Throttle Cable .....                                    | 2-54        | Reading .....                           | 2-45        |
| 5-8 HP (164cc) .....                                    | 2-54        | Removal & Installation .....            | 2-44        |
| STROKE MODELS .....                                     | 2-54        | SPARK PLUG WIRES .....                  | 2-47        |
| Low Speed & Wide Open Throttle Settings .....           | 2-55        | Removal & Installation .....            | 2-47        |
| Throttle Cable .....                                    | 2-55        | Testing .....                           | 2-47        |
| Timing Pointer and Idle Timing (1990) .....             | 2-55        | TUNE-UP SEQUENCE .....                  | 2-40        |
| 5/6 HP (128cc) & 8/9.9 HP (211cc) 4-STROKE MODELS ..... | 2-56        | <b>VALVE CLEARANCE (4-STROKE)</b> ..... | <b>2-78</b> |
|   |             | VALVE LASH ADJUSTMENT .....             | 2-78        |

# 2

## MAINTENANCE & TUNE-UP

|                                  |      |
|----------------------------------|------|
| GENERAL INFORMATION .....        | 2-2  |
| LUBRICATION SERVICE .....        | 2-6  |
| ENGINE MAINTENANCE .....         | 2-15 |
| BOAT MAINTENANCE .....           | 2-37 |
| TUNE-UP .....                    | 2-40 |
| TIMING AND SYNCHRONIZATION ..... | 2-51 |
| VALVE CLEARANCE(4-STROKE) .....  | 2-78 |
| STORAGE .....                    | 2-81 |
| CLEARING A SUBMERGED MOTOR ..... | 2-83 |
| SPECIFICATIONS .....             | 2-85 |

## 2-2 MAINTENANCE & TUNE-UP

### GENERAL INFORMATION (WHAT EVERYONE SHOULD KNOW ABOUT MAINTENANCE)

At Seloc, we estimate that 75% of engine repair work can be directly or indirectly attributed to lack of proper care for the engine. This is especially true of care during the off-season period. There is no way on this green earth for a mechanical engine, particularly an outboard motor, to be left sitting idle for an extended period of time, say for six months, and then be ready for instant satisfactory service.

Imagine, if you will, leaving your car or truck for six months, and then expecting to turn the key, having it roar to life, and being able to drive off in the same manner as a daily occurrence.

Therefore it is critical for an outboard engine to either be run (at least once a month), preferably, in the water and properly maintained between uses or for it to be specifically prepared for storage and serviced again immediately before the start of the season.

Only through a regular maintenance program can the owner expect to receive long life and satisfactory performance at minimum cost.

Many times, if an outboard is not performing properly, the owner will "nurse" it through the season with good intentions of working on the unit once it is no longer being used. As with many New Year's resolutions, the good intentions are not completed and the outboard may lie for many months before the work is begun or the unit is taken to the marine shop for repair.

Imagine, if you will, the cause of the problem being a blown head gasket. And let us assume water has found its way into a cylinder. This water, allowed to remain over a long period of time, will do considerably more damage than it would have if the unit had been disassembled and the repair work performed immediately. Therefore, if an outboard is not functioning properly, do not stow it away with promises to get at it when you get time, because the work and expense will only get worse, the longer corrective action is postponed. In the example of the blown head gasket, a relatively simple and inexpensive repair job could very well develop into major overhaul and rebuild work.

### Maintenance Equals Safety

OK, perhaps no one thing that we do as boaters will protect us from risks involved with enjoying the wind and the water on a powerboat. But, each time we perform maintenance on our boat or motor, we increase the likelihood that we will find a potential hazard before it becomes a problem. Each time we inspect our boat and motor, we decrease the possibility that it could leave us stranded on the water.

In this way, performing boat and engine service is one of the most important ways that we, as boaters, can help protect ourselves, our boats, and the friends and family that we bring aboard.

### Outboards On Sail Boats

Owners of sailboats pride themselves in their ability to use the wind to clear a harbor or for movement from Port A to Port B, or maybe just for a day sail on a lake. For some, the outboard is carried only as a last resort - in case the wind fails completely, or in an emergency situation or for ease of docking.

Therefore, in some cases, the outboard is stowed below, usually in a very poorly ventilated area, and subjected to moisture and stale air - in short, an excellent environment for "sweating" and corrosion.

If the owner could just take the time at least once every month, to pull out the outboard, clean it up, and give it a short run, not only would he/she have "peace of mind" knowing it will start in an emergency, but also maintenance costs will be drastically reduced.

### Maintenance Coverage In This Manual

At Seloc, we strongly feel that every boat owner should pay close attention to this section. We also know that it is one of the most frequently used portions of our manuals. The material in this section is divided into sections to help simplify the process of maintenance. Be sure to read and thoroughly understand the various tasks that are necessary to keep your outboard in tip-top shape.

Topics covered in this section include:

1. General Information (What Everyone Should Know About Maintenance) - an introduction to the benefits and need for proper maintenance. A guide to tasks that should be performed before and after each use.

2. Lubrication Service - after the basic inspections that you should perform each time the motor is used, the most frequent form of periodic maintenance you will conduct will be the Lubrication Service. This section takes you through each of the various steps you must take to keep corrosion from slowly destroying your motor before your very eyes.

3. Engine Maintenance - the various procedures that must be performed on a regular basis in order to keep the motor and all of its various systems operating properly.

4. Boat Maintenance - the various procedures that must be performed on a regular basis in order to keep the boat hull and its accessories looking and working like new.

5. Tune-Up - also known as the pre-season tune-up, but don't let the name fool you. A complete tune-up is the best way to determine the condition of your outboard while also preparing it for hours and hours of hopefully trouble-free enjoyment.

6. Winter Storage and Spring Commissioning Checklists - use these sections to guide you through the various parts of boat and motor maintenance that protect your valued boat through periods of storage and return it to operating condition when it is time to use it again.

7. Specification Charts - located at the end of the section are quick-reference, easy to read charts that provide you with critical information such as General Engine Specifications, Maintenance Intervals, Lubrication Service (intervals and lubricant types) and Capacities.

### Engine Identification

#### ◆ See Figures 1 and 2

From 1990 to 2001 Johnson and Evinrude produced a large number of models with regards to horsepower ratings, as well a large number of trim and option variances on each of those models. In this manual, we've included all of the 1-4 cylinder inline models (of both 2 and 4-stroke designs). We chose to do this because of the many similarities these motors have to each other. But, enough differences exist that many procedures will apply only to a sub-set of these motors. When this occurs, we'll either refer to the differences within a procedure or, if the differences are significant, we'll break the motors out and give separate procedures. In order to prevent confusion, we try to sort and name the models in a way that is most easily understood.

In many cases, it is simply not enough to refer to a motor as a 9.9 hp model, since in these years Johnson/Evinrude produced four different 2-cylinder motors with that rating (the 211cc 4-stroke, the 216cc 2-stroke, the 255cc 2-stroke, and the 305cc 4-stroke). Across that same year span, Johnson/Evinrude produced and sold no fewer than 4 different 2-stroke motors rated at 25hp (the 2-cylinder 521cc, the 2-cylinder 737cc, the 3-cylinder 913cc and the 3-cylinder 933cc). This makes proper engine identification important for everything from ordering parts to even just using the procedures in this manual.

Throughout this manual we will make reference to motors the easiest way possible. In some cases procedures will apply to all 2-strokes or all 4-strokes, in other cases, they will apply to all 1-cylinder or all 2-cylinder motor (or all 3 or 4-cylinder motors, as applicable). When it is necessary to distinguish between different types of motors with the same number of cylinders, we'll differentiate using the Hp rating or, since different motors may have the same rating, we'll use the Hp rating plus the size. In most cases, mechanical procedures will be similar or the same across different Hp ratings of the same engine family (of the same size). So it won't be uncommon to see a title or a procedure refer to 9.9/15 hp (255cc) motors or 9.9/15 hp (305cc) motors. In both cases, we would be referring to the 9.9 or 15 hp motors of a particular family, including all Rope Start, Tiller Electric or Remote Electric Models. In the case of the 9.9/15 hp (255cc) motors, we would be referring to the 2-strokes, of that size, including any Sail, Commercial or other special models.

To help with proper engine identification, all of the engines covered by this manual are listed in the General Engine and General Engine System Specifications charts at the end of this section. In these charts, the engines are listed with their respective engine families, by horsepower rating, number of cylinders, engine type (2- or 4-stroke), years of production and displacement (cubic inches and cubic centimeters or CCs).

But, whether you are trying to tell which version of a particular horsepower rated motor you have in order to follow the correct procedure or are trying to order replacement parts, the absolute best method is to start by referring to the engine serial number tag. For all models covered by this

manual an ID tag (A, in the accompanying figure) is located on the port side of the engine clamp or swivel/tilt brackets. Most models are also equipped with an Emissions Control Information label (B, in the accompanying figure) as well.

## ENGINE SERIAL NUMBERS

### ◆ See Figure 2

The engine serial numbers are the manufacturer's key to engine changes. These alpha-numeric codes identify the year of manufacture, the horsepower rating, gearcase shaft length and various model/option differences (such as rope start, tiller electric or remote electric models). If any correspondence or parts are required, the engine serial number must be used for proper identification.

Remember that the serial number establishes the year in which the engine was produced, which is often not the year of first installation.

The engine serial number tag contains information such as the plant in which the motor was produced, the model number or code, the serial number (a unique sequential identifier given ONLY to that one motor) as well as other useful information such as weight (mass) in Kilograms (kg).

The emissions control information label states that the motor is in compliance with EPA emissions regulations for the model year of that engine. And, more importantly, it gives tune-up specifications that are vital to proper engine performance (that minimize harmful emissions). The

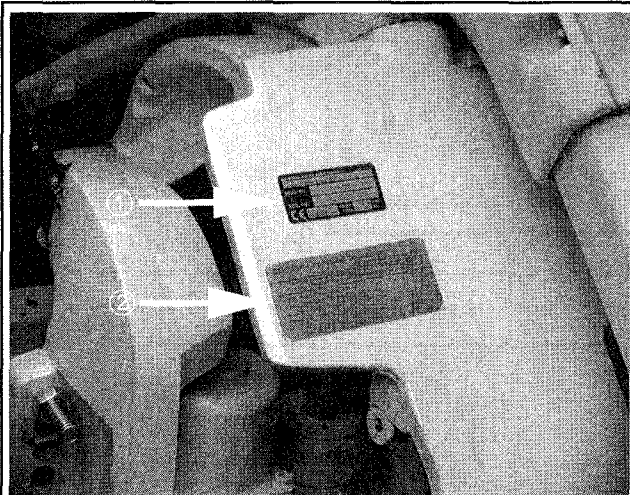

**Fig. 1** A model ID tag (A) and an emission control label (B) is found on the port side of most engine clamp or swivel/tilt brackets

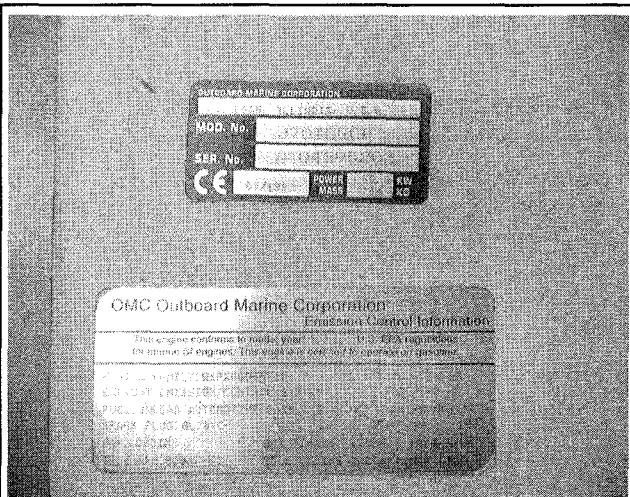

**Fig. 2** The model ID tag (top) and emission label (bottom) provide critical information to identify and service the engine

specifications on this label may reflect changes that are made during production runs and are often not later reflected in a company's service literature. For this reason, specifications on the label always supercede those of a print manual. Typical specifications that are found on this label will include:

- Spark plug type and gap.
- Fuel recommendations.
- Idle speed settings
- Engine timing ignition (such as wide-open throttle and/or idle timing) specification
- Engine displacement (in Cubic Inches or Cubic Centimeters, as noted on the label)

### Deciphering The Model Code on 1990-98 Engines

#### ◆ See Figure 3

Engines built for the 1990-98 model years (and all Johnson/Evinrude engines built back through 1980) will contain an 8-12 digit code for identification. If the code begins with A, B, C, H, S, T or V, it represents a model variation (a model built for use in certain countries or specifically for a boat-builder to include with their new boat). If one of these alphas is not present, the code should start with J (for Johnson) or E (for Evinrude). The next one, two or three digits will be numbers, representing the horsepower rating. The digit following the horsepower rating will be a one, two or three digit alpha code identifying the various trim/model types (such as TE for tiller electric or FRE for 4-stroke, electric start/remote). Following the model identifier may be a single alpha identifier (L, Y, X or Z) representing gearcase shaft length (a lack of this identifier would represent a 15 in. shaft length). Next, a two-digit, alpha identifier is used for the year. And lastly, the manufacturer internally uses a single check digit to designate the model run.

Refer to the accompanying illustration to interpret the various alpha identifiers found throughout the model code.

■ Starting in 1980, OMC began using the word **INTRODUCES** as an easy way to decipher model years. The 10 letters of that word correspond to the digits 1-9 and 0, in that order. The first letter "I" represents a 1, the second letter "N" represents a 2 and so on until "S" which represents a 0. When deciphering a model code, each of the two alpha identifiers correspond to the last two digits of the model year. A 1998 model would therefore be EC, a 1996 would be ED, and so on. For quick deciphering, right out the word **INTRODUCES** and then number the letters from 1-9 and then 0.

### Deciphering The Model Code on 1999-01 Engines

#### ◆ See Figure 4

Engines built for the 1999-01 model years contain a simplified version of the model code (when compared with earlier models) containing only 7-8 digits. In all cases, the identifier should start with a single alpha representing Johnson (J) or Evinrude (E). The next one, two or three digits will be numbers, representing the horsepower rating. The digit following the horsepower rating will be a single one or two digit alpha/numeric code identifying design features/model types (such as W for commercial models, T for tiller steering or 4 for 4-stroke). Following the design feature/model identifier may be a single alpha identifier (L, Y, X or Z) representing gearcase shaft length (a lack of this identifier would represent a 15 in. shaft length). Next, a two-digit, alpha identifier is used for the year and is deciphered in the same manner as all Johnson/Evinrude models numbers since 1980. Finally, in some cases, a single check digit is used by the manufacturer internally to designate the model run.

Refer to the accompanying illustration to interpret the various alpha digits found throughout the model code.

## Before/After Each Use

As stated earlier, the best means of extending engine life and helping to protect yourself while on the water is to pay close attention to boat/engine maintenance. This starts with an inspection of systems and components before and after each time you use your boat.

A list of checks, inspections or required maintenance can be found in the Maintenance Intervals Chart at the end of this section. Some of these inspections or tasks are performed before the boat is launched, some only after it is retrieved and the rest, both times.

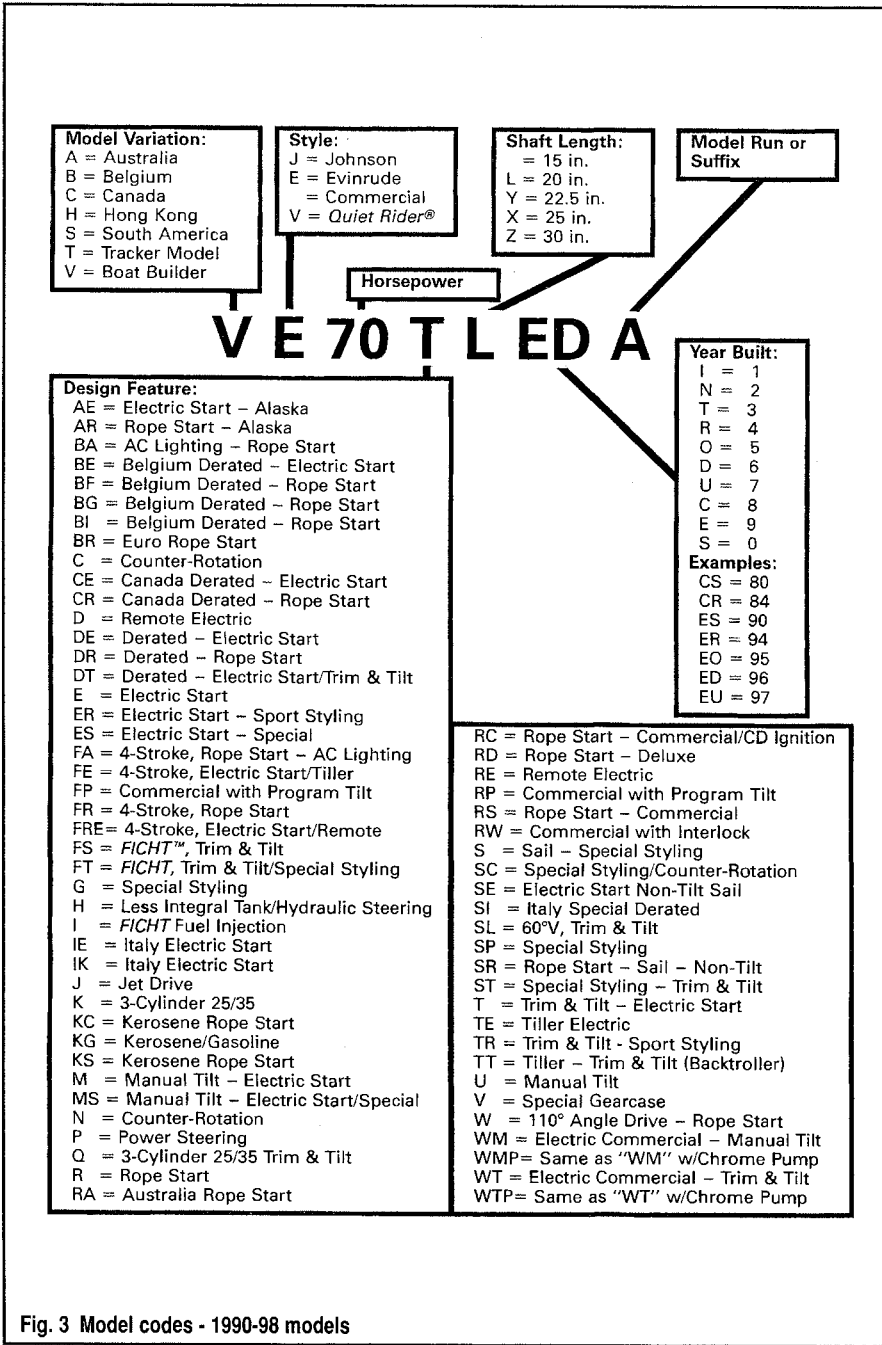

Fig. 3 Model codes - 1990-98 models

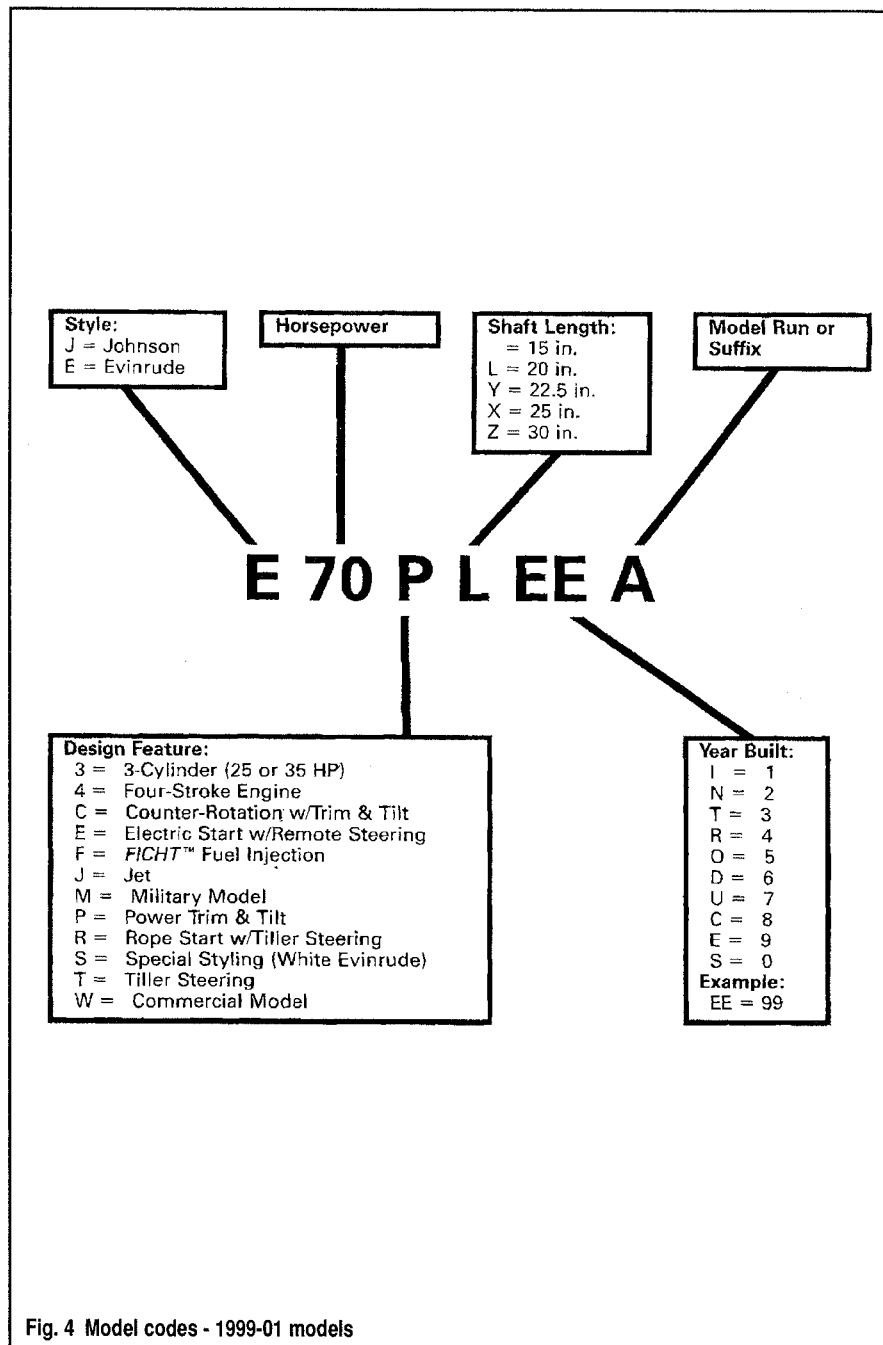
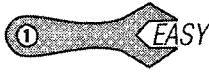

Fig. 4 Model codes - 1999-01 models

## VISUALLY INSPECTING THE BOAT AND MOTOR



### ◆ See Figures 5 and 6

Both before each launch and immediately after each retrieval, visually inspect the boat and motor as follows:

1. **Check the fuel and oil levels** according to the procedures in this manual. Do NOT launch a boat without properly topped off fuel and oil tanks (or without the proper crankcase oil level on 4-stroke motors). It is not worth the risk of getting stranded or of damage to the motor. Likewise, upon retrieval, check the oil and fuel levels while it is still fresh in your mind. This is a good way to track fuel consumption (one indication of engine performance). For 2-stroke motors, compare the fuel consumption to the oil consumption (a dramatic change in proportional use may be an early sign of trouble). For 4-stroke motors, oil consumption should be minimal, but all 4-stroke engines allow a small portion of oil to burn. Watch for sudden increases in the amount of oil burned and investigate further if found.

2. **Check for signs of fuel or oil leakage.** Probably as important as making sure enough fuel and oil is onboard, is the need to make sure that no dangerous conditions might arise due to leaks. Thoroughly check all hoses, fittings and tanks for signs of leakage. Oil leaks may cause the boat to become stranded, or worse, could destroy the motor if undetected for a significant amount of time. Fuel leaks can cause a fire hazard, or worse, an explosive condition. This check is not only about properly maintaining your boat and motor, but about helping to protect your life.

3. **Inspect the boat hull and engine cases** for signs of corrosion or damage. Don't launch a damaged boat or motor. And don't surprise yourself dockside or at the launch ramp by discovering damage that went unnoticed last time the boat was retrieved. Repair any hull or case damage now.

4. **Check the battery connections** to make sure they are clean and tight. A loose or corroded connection will cause charging problems (damaging the system or preventing charging). There's only one thing worse than a dead battery dockside/launch ramp and that's a dead battery in the middle of a bay, river or worse, the ocean. Whenever possible, make a quick visual check of battery electrolyte levels (keeping an eye on the level will give some warning of overcharging problems). This is especially true if the engine is operated at high speeds for extended periods of time.

5. **Check the propeller (impeller on jet drives and rotor on RescuePro® motors) and gearcase.** Make sure the propeller shows no signs of damage. A broken or bent propeller may allow the engine to over-rev and it will certainly waste fuel. The gearcase should be checked before and after each use for signs of leakage. Check the gearcase oil for signs of contamination if any leakage is noted. Also, visually check behind the propeller for signs of entangled rope or fishing lines that could cut through the lower gearcase propeller shaft seal. This is a common cause of gearcase

lubricant leakage, and eventually, water contamination that can lead to gearcase failure. Even if no gearcase leakage is noted when the boat is first retrieved, check again next time before launching. A nicked seal might not seep fluid right away when still swollen from heat immediately after use, but might begin seeping over the next day, week or month as it sat, cooled and dried out.

6. **Check all accessible fasteners for tightness.** Make sure all easily accessible fasteners appear to be tight. This is especially true for the propeller nut, any anode retaining bolts, all steering or throttle linkage fasteners and the engine clamps or mounting bolts. Don't risk losing control or becoming stranded due to loose fasteners. Perform these checks before heading out, and immediately after you return (so you'll know if anything needs to be serviced before you want to launch again.)

7. **Check operation of all controls including the throttle/shifter, steering and emergency stop/start switch and/or safety lanyard.** Before launching, make sure that all linkage and steering components operate properly and move smoothly through their range of motion. All electrical switches (such as power trim/tilt) and especially the emergency stop system(s) must be in proper working order. While underway, watch for signs that a system is not working or has become damaged. With the steering, shifter or throttle, keep a watchful eye out for a change in resistance or the start of jerky/notchy movement.

8. **Check the water pump intake grate and water indicator.** The water pump intake grate should be clean and undamaged before setting out. Remember that a damaged grate could allow debris into the system that could destroy the impeller or clog cooling passages. Once underway, make sure the cooling indicator stream is visible at all times. Make periodic checks, including one final check before the motor is shut down each time. If a cooling indicator stream is not present at any point, troubleshoot the problem before further engine operation.

9. **If equipped, check the power steering belt and fluid level.** A quick visual inspection of the power steering belt and fluid level at the end of each day will warn of problems that should be fixed before the next launch.

10. **If used in salt, brackish or polluted waters thoroughly rinse the engine (and hull), then flush the cooling system** according to the procedure in this section.

11. **Visually inspect all anodes** after each use for signs of wear, damage or to make sure they just plain didn't fall off (especially if you weren't careful about checking all the accessible fasteners the last time you launched).

12. **On EFI models, be sure to shut the battery switch off** if the engine is not going to be run for a couple of weeks or more. The Engine Control Unit (ECU) on fuel-injected motors covered by this manual will continue to draw a small amount of current from the battery, even when the motor is shut off. In order to prevent a slow drain of the entire battery, either periodically recharge the battery, or isolate it by disconnecting the cables or shutting off the battery switch when the boat is dockside or on the trailer.

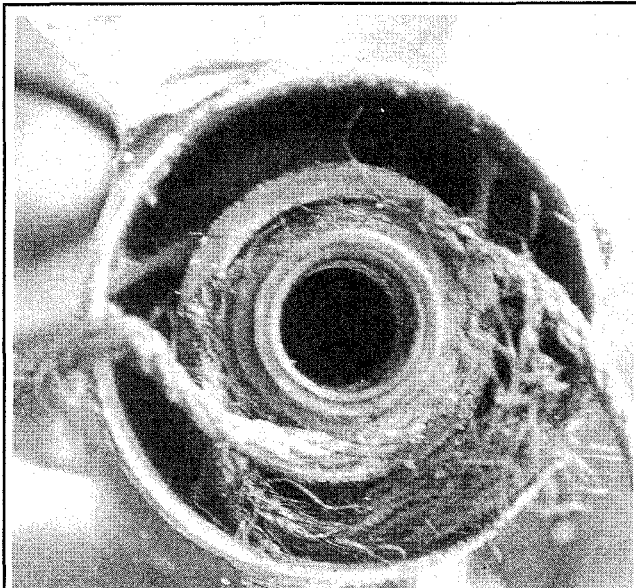

Fig. 5 Rope and fishing line entangled behind the propeller can cut through the seal, allowing water to enter and lubricant to escape

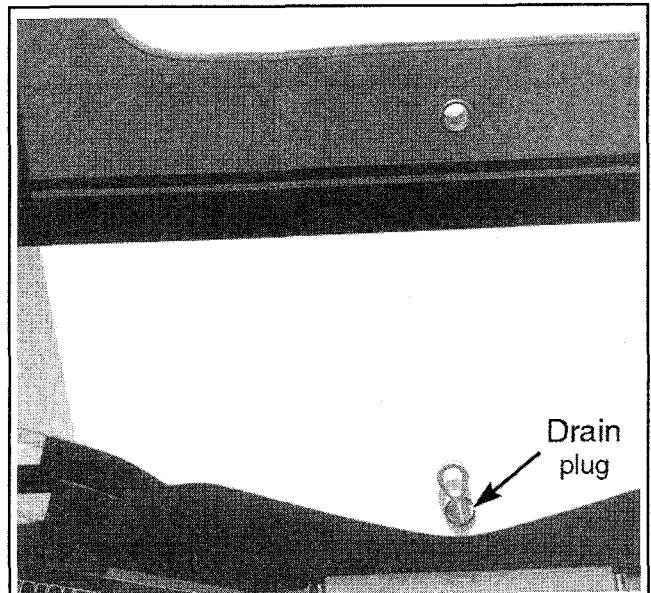

Fig. 6 Always make sure the transom plug is installed and tightened securely before a launch

## 2-6 MAINTENANCE & TUNE-UP

■ If the boat is not equipped with a battery switch, remove the green 30 amp fuse from the fuse holder found on the side of the engine. Of course, if this is done, tape the fuse to an obvious point so it will be installed before the next attempt to start the motor. This could save some embarrassing and frustrating troubleshooting time if the fact that it was removed becomes lost in your memory.

### LUBRICATION SERVICE

An outboard motor's greatest enemy is corrosion. Face it, oil and water just don't mix and, as anyone who has visited a junkyard knows, metal and water aren't the greatest of friends either. To expose an engine to a harsh marine environment of water and wind is to expect that these elements will take their toll over time. But, there is a way to fight back and help prevent the natural process of corrosion that will destroy your beloved boat motor.

Various marine grade lubricants are available that serve two important functions in preserving your motor. Lubricants reduce friction on metal-to-metal contact surfaces and, they also displace air and moisture, therefore slowing or preventing corrosion damage. Periodic lubrication services are your best method of preserving an outboard motor.

Lubrication takes place through various forms. For all engines, internal moving parts are lubricated by engine oil, either through oil contained in the fuel/oil mixture on 2-stroke motors, or the oil contained in the engine crankcase and pumped through oil passages in 4-stroke motors. On all motors (both 2 and 4-stroke) the gearcase is filled with gear oil that lubricates the driveshaft, propshaft, gears and other internal gearcase components. The gear oil for all motors and the engine crankcase oil on 4-stroke motors should be periodically checked and replaced following the appropriate Engine Maintenance procedures. Perform these services based on time or engine use, as outlined in the Maintenance Intervals chart at the end of this section.

For motors equipped with power trim/tilt, the fluid level and condition in the reservoir should be checked periodically to ensure proper operation. Also, on these motors, correct fluid level is necessary to ensure operation of the motor impact protection system.

### \*\* WARNING

**When equipped with power trim/tilt, proper fluid level is necessary for the built-in impact protection system. Incorrect fluid level could lead to significant gearcase damage in the event of an impact.**

Most other forms of lubrication occur through the application of grease (OMC Triple-Guard, OMC EP/Wheel bearing grease, OMC Starter Pinion Lube, or their equivalents) to various points on the motor. These lubricants are either applied by hand (an old toothbrush can be helpful in preventing a mess) or using a grease gun to pump the lubricant into grease fittings (also known as zerk fittings). When using a grease gun, do not pump excessive amounts of grease into the fitting. Unless otherwise directed, pump until either the rubber seal (if used) begins to expand or until the grease just

13. **For Pete's sake, make sure the plug is in!** We shouldn't have to say it, but unfortunately we do. If you've been boating for any length of time, you've seen or heard of someone whose backed a trailer down a launch ramp, forgetting to check the transom drain plug before submerging (literally) the boat. Always make sure the transom plug is installed and tight before a launch.

begins to seep from the joints of the component being lubricated (if no seal is used).

To ensure your motor is getting the protection it needs, perform a visual inspection of the various lubrication points at least once a week during regular seasonal operation (this assumes that the motor is being used at least once a week). Follow the recommendations given in the Lubrication Chart at the end of this section and perform the various lubricating services at least every 60 days when the boat is operated in fresh water or every 30 days when the boat is operated in salt, brackish or polluted waters. We said **at least** meaning you should perform these services more often, as discovered by your weekly inspections.

■ **Jet drive models require one form of lubrication every time that they are used. The jet drive bearing should be greased, following the procedure given in this section, after every day of boating. But don't worry, it only takes a minute once you've done it before.**

### Electric Starter Motor Pinion

#### RECOMMENDED LUBRICANT

Use OMC Starter Pinion lubricant.

#### LUBRICATION

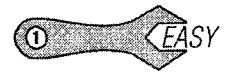

◆ See Figures 7 and 8

The starter pinion is the gear and slider assembly located on the top of the starter motor as it is mounted to the engine. When power is applied to the starter, the gear on the pinion assembly slides upward to contact and mesh with the gear teeth on the outside of the flywheel. Periodically, apply a small amount of lubricant to the sliding surface of the starter pinion in order to prevent excessive wear or possible binding on the shaft.

■ **Access to the starter pinion is possible on most models by reaching under the flywheel cover using an applicator. But, in most cases, removal of the flywheel cover and/or manual starter assembly will make it much easier. If necessary refer to the Flywheel Cover or Manual Starter Assembly removal procedures for details.**

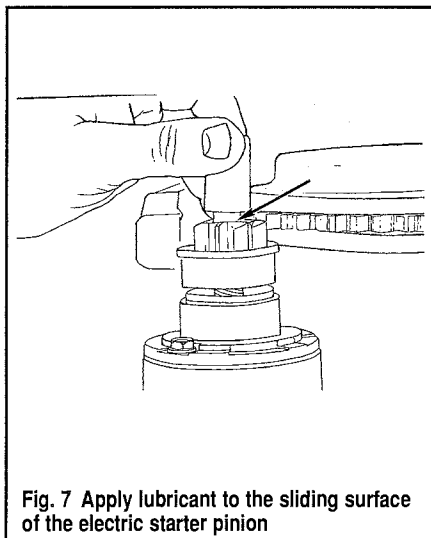

Fig. 7 Apply lubricant to the sliding surface of the electric starter pinion

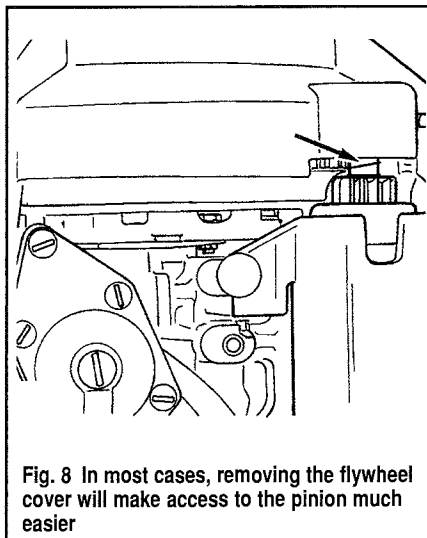

Fig. 8 In most cases, removing the flywheel cover will make access to the pinion much easier

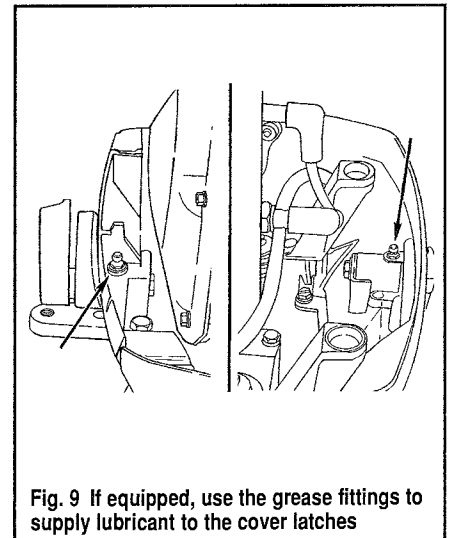

Fig. 9 If equipped, use the grease fittings to supply lubricant to the cover latches



## Engine Cover Latches

### RECOMMENDED LUBRICANT

Use OMC Triple-Guard, or an equivalent water-resistant marine grease for lubrication.

### LUBRICATION

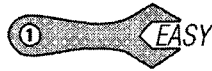

#### ◆ See Figures 9

Although the sliding surfaces of all cover latches can benefit from an application of grease, the design of the latches used on all 737cc and larger 2-stroke motors makes periodic greasing necessary to prevent the latches from binding or wearing. Depending on the latch type, either apply a small amount of grease to the metal surfaces using an applicator brush (this is typically necessary on 2-cylinder models) or use a grease gun to pump grease into the zerk fitting facing upward from the latch assembly.

## Engine Mount Clamp Screws

#### ◆ See Figure 10

### RECOMMENDED LUBRICANT

Use OMC Triple-Guard, or an equivalent water-resistant marine grease for lubrication.

### LUBRICATION

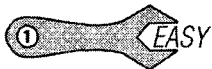

#### ◆ See Figure 10

Many of the models covered by this manual are designed to be portable or permanently installed. Although installation and rigging will vary, if the motor is not permanently mounted in place, the threads of the engine mount clamp screws should be lubricated periodically. Apply a light coating of a suitable marine grease to the threads of both clamp screws. If necessary, apply the grease and loosen the clamp to ensure the grease is drawn through the threaded portion of the bracket, then retighten the clamp and repeat for the remaining clamp. When you are finished, be certain that the clamps are properly tightened. Also, pay extra attention to the clamps before and after the next use, to make sure they remain tightened.

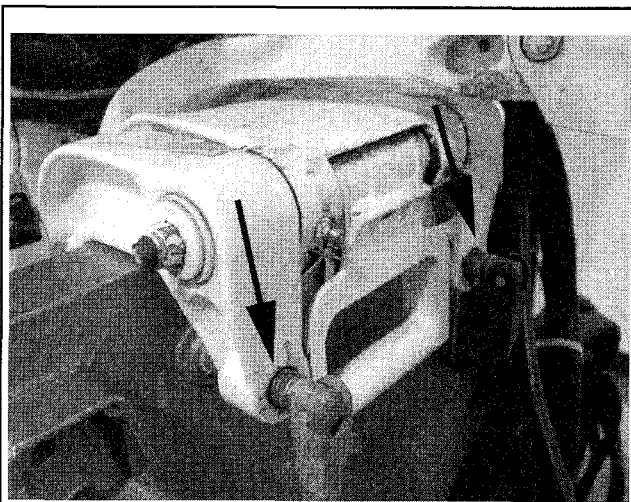

**Fig. 10** When equipped, be sure to apply lubricant to the threads on the engine mount clamps

## Jet Drive Bearing

#### ◆ See Figure 11

Jet drive models covered by this manual require special attention to ensure that the driveshaft bearing remains properly lubricated.

After each day of use, the jet drive bearing should be properly lubricated using a grease gun. Also, after every 30 hours of fresh water operation or every 15 hours of salt/brackish/polluted water operation, the drive bearing grease must be replaced. Follow the appropriate procedure:

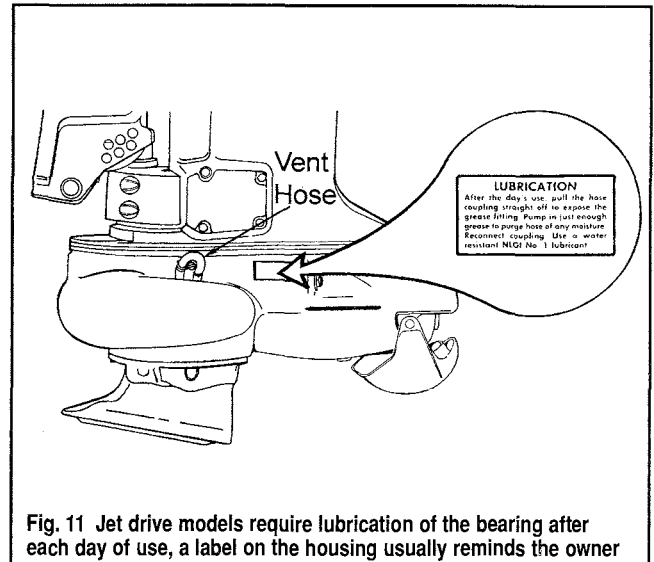
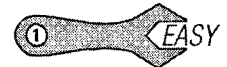

**Fig. 11** Jet drive models require lubrication of the bearing after each day of use, a label on the housing usually reminds the owner

### RECOMMENDED LUBRICANT

Use OMC EP/Wheel Bearing grease or an equivalent water-resistant NLGI No. 1 lubricant.

### DAILY BEARING LUBRICATION



#### ◆ See Figures 12 and 13

A grease fitting is located under a vent hose on the lower port side of the jet drive. Disconnect the hose from the fitting, then use a grease gun to apply enough grease to the fitting to **just** fill the vent hose. Basically, grease is pumped into the fitting until the old grease just starts to come out from the passages through the hose coupling, then reconnect the hose to the fitting.

**■ Do not attempt to just grasp the vent hose and pull, as it is a tight fit and when it does come off, you'll probably go flying if you didn't prepare for it. The easier method of removing the vent hose from the fitting is to deflect the hose to one side and snap it free from the fitting.**

### GREASE REPLACEMENT

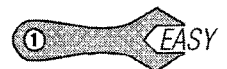

#### ◆ See Figures 12, 13 and 14

A grease fitting is located under a vent hose on the lower port side of the jet drive. This grease fitting is utilized at the end of each day's use to add fresh grease to the jet drive bearing. But, every 30 or 15 days (depending if use is in fresh or salt/brackish/polluted waters), the grease should be completely replaced. This is very similar to the daily greasing, except that a lot more grease is used. Disconnect the hose from the fitting (by deflecting it to the side until it snaps free from the fitting), then use a grease gun to apply enough grease to the fitting until grease exiting the assembly fills the vent hose. Then, continue to pump grease into the fitting to force out all of the old

## 2-8 MAINTENANCE & TUNE-UP

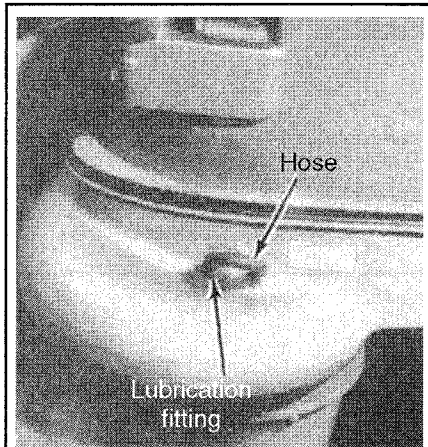

**Fig. 12** The jet drive lubrication fitting is found under the vent hose

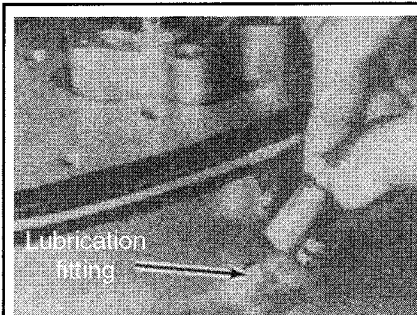

**Fig. 13** Attach a grease gun to the fitting for lubrication

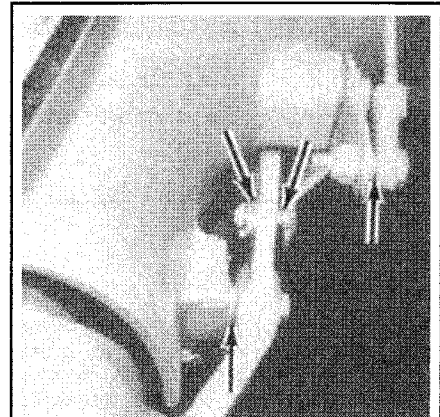

**Fig. 14** Also, coat the pivot points of the jet linkage with grease periodically

grease (you can tell this has been accomplished when fresh grease starts to come out of the vent instead of old grease, which will be slightly darker due to minor contamination from normal use). When nothing but fresh grease comes out of the vent the fresh grease has completely displaced the old grease and you are finished. Be sure to securely connect the vent hose to the fitting.

Each time this is performed, inspect the grease for signs of moisture contamination or discoloration. A gradual increase in moisture content over a few services is a sign of seal wear that is beginning to allow some seepage. Very dark or dirty grease may indicate a worn seal (inspect and/or replace the seal, as necessary to prevent severe engine damage should the seal fail completely).

■ **Keep in mind that some discoloration of the grease is expected when a new seal is broken-in. The discoloration should go away gradually after one or two additional grease replacement services.**

Whenever the jet drive bearing grease is replaced, take a few minutes to apply some of that same water-resistant marine grease to the pivot points of the jet linkage.

### Power Trim/Tilt Reservoir

◆ See Figure 15

### \*\* WARNING

**When equipped with power trim/tilt, proper fluid level is necessary for the built-in impact protection system. Incorrect fluid level could lead to significant gearcase damage in the event of an impact.**

### RECOMMENDED LUBRICANT

The power trim/tilt reservoir must be kept full of OMC Power Trim/Tilt and Power Steering Fluid.

### CHECKING FLUID LEVEL/CONDITION

◆ See Figure 15

The fluid in the power trim/tilt reservoir should be checked periodically to ensure it is full and is not contaminated. To check the fluid, tilt the motor upward to the full tilt position, then manually engage the tilt support for safety and to prevent damage. Remove the filler cap (they are usually threaded in position) and make a visual inspection of the fluid. It should seem clear and not milky. The level is proper if, with the motor at full tilt, the level is even with the bottom of the filler cap hole.

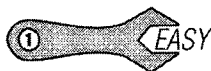

### Linkage, Cables and Shafts (Choke, Shift, Carburetor and/or Throttle Shaft)

#### RECOMMENDED LUBRICANT

Use OMC Triple-Guard, or an equivalent water-resistant marine grease for lubrication.

#### LUBRICATION

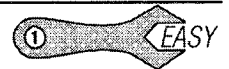

Every Johnson and Evinrude outboard uses some combination of cables and/or linkage in order to actuate the throttle plate (of the carburetor, carburetors or throttle body), the gearcase shifter and, on some smaller carbureted motors, the choke plate. Because linkage and cables contain moving parts that work in contact with other moving parts, the contact points can become worn and loose if proper lubrication is not maintained. These small parts are also susceptible to corrosion and breakage if they are not protected from moisture by light coatings of grease. Periodically apply a light coating of suitable water-resistant marine grease on each of these surfaces where either two moving parts meet or where a cable end enters a housing. For more details on grease points refer to the accompanying illustrations.

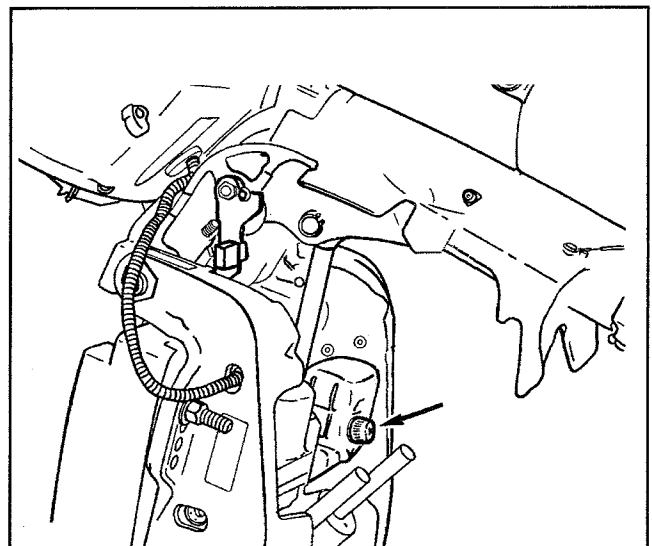

**Fig. 15** Maintaining the proper power trim/tilt fluid level is critical to protecting the engine in case of an impact