

P/N 7788853-5  
8-1995

# **Workshop Manual**

## **"HU" Models**

Early "NC" Models

**TBI Diagnostic (4.3 Gi, 5.7 Gi) - GM**

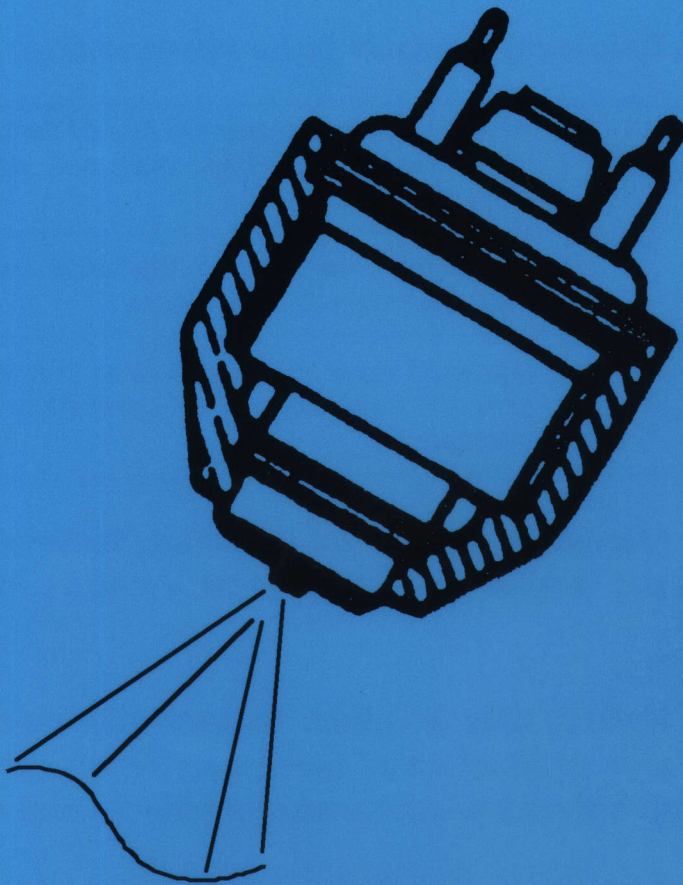



**VOLVO  
PENTA**

## Safety Warning

This Workshop Manual will alert you to certain procedures that must be done very carefully. If you ignore this information, you could...

- Injure yourself or people around you
- Injure the boat operator, boat passengers, or people around the boat
- Damage the Volvo Penta product or its systems

Understand the following symbols before proceeding:

 <b>Safety Warning</b>	Alerts you to the possibility of danger and identifies information that will help prevent injuries.
 <b>Note</b>	Identifies information that will help prevent damage to machinery.
 <b>Important</b>	Appears next to information that controls correct assembly and operation of the product.

This Workshop Manual is written for qualified, factory trained service technicians familiar with the use of Volvo Penta special tools.

This Workshop Manual tells you how to correctly maintain and service Volvo Penta products and systems. When correctly serviced, the Volvo Penta product will be reliable and safe to operate.

When Volvo Penta special tools are called for, use them. Where mentioned, the tools are required to perform the service procedure.

If you use service procedures or service tools that are not recommended in this manual, **YOU ALONE** must decide if your actions might injure people or damage the Volvo Penta product.

# MARINE ELECTRONIC FUEL INJECTION (MEFI) DIAGNOSTIC MANUAL

The Table of Contents on the following page indicates the sections covered in this manual. At the beginning of each individual section is a Table of Contents which gives the page number on which each subject begins.

When reference is made in this manual to a brand name, number, or specific tool, an equivalent product may be used in place of the recommended item.

All information, illustrations, and specifications contained in this manual are based on the latest product information available at the time of publication approval. The right is reserved to make changes at any time without notice.

**NOTICE:** When fasteners are removed, always reinstall them at the same location from which they were removed. If a fastener needs to be replaced, use the correct part number fastener for that application. If the correct part number fastener is not available, a fastener of equal size and strength (or stronger) may be used. Fasteners that are not reused, and those requiring thread locking compound will be called out. The correct torque value must be used when installing fasteners that require it. If the above conditions are not followed, parts or system damage could result.

## Safety Warning

Before performing any tests or checks recommended in this manual, read the section called **Safety** located at the end of this manual.

This manual has been published with written permission from the GM Powertrain Division of General Motors Corp. No part of this publication may be reproduced, stored in any retrieval system, or transmitted, in any form or by any means, including but not limited to electronic, mechanical, photocopying, recording or otherwise, without the prior written permission of the GM Powertrain Division of General Motors Corp. This includes all text, illustrations, tables and charts.

This workshop manual is one of a set of nine that covers *Volvo Penta* stern drive models. All nine books can be ordered as a set from *Volvo Penta Parts*. Order P/N 7788850-1.

Individual workshop manuals covering these models are also available. Order the following part numbers from *Volvo Penta Parts*.

- **P/N 7788851-9 *SX Drive Unit and Transom Shield***  
Includes information on Transom Shield, Upper Gear Unit and Lower Gear Unit service; Drive Unit removal and installation; Propellers; and Trim/Tilt hydraulic operation.
- **P/N 7788856-8 *Engine Components***  
Includes information on Engine service and troubleshooting; Engine removal and installation; Steering systems; Throttle and Shift Control systems; and Cooling systems.
- **P/N 7788857-6 *Electrical & Ignition System***  
Includes service and troubleshooting information on Cranking systems; Charging systems; Trim/Tilt electrical systems; Ignition systems; and Engine and Instrument wiring diagrams.
- **P/N 7788858-4 *Fuel System***  
Includes service and troubleshooting information on all carburetor, MFI and TBI fuel systems and related components.
- **P/N 7788852-7 *MFI Diagnostic Manual (5.0 Fi, 5.8 Fi/FSi) - Ford***  
Includes step by step troubleshooting procedures for all MFI Ford related components and wiring.
- **P/N 7788853-5 *TBI Diagnostic Manual (4.3 Gi, 5.7 Gi) - GM***  
Contains troubleshooting procedures for all TBI GM models and related components.
- **P/N 7788855-0 *SP and DP Workshop Manual***  
Includes Upper Gear Unit and Lower Gear Unit overhaul procedures, installation and removal.
- **P/N 7788854-3 *MFI Diagnostic Manual (7.4 Gi, 7.4 GSi) - GM***  
Includes step by step troubleshooting procedures for all MFI GM related components and wiring.
- **P/N 7788859-0 *DPX - Lower Unit Workshop Manual***  
Includes specific information for repair and overhaul of the DPX Lower unit and Xact™ steering systems not covered in the SP and DP Workshop manual.

# CONTENTS

<b>FORWARD.....</b>	<b>I</b>
<b>GENERAL INFORMATION.....</b>	<b>1</b>
<b>ENGINE CONTROL MODULE (ECM) AND SENSORS.....</b>	<b>2</b>
<b>FUEL METERING SYSTEM.....</b>	<b>3</b>
<b>SPARK MANAGEMENT SYSTEM.....</b>	<b>4</b>
<b>TBI DIAGNOSIS.....</b>	<b>5</b>
<b>TBI SYSTEMS.....</b>	<b>6</b>
<b>ON BOARD SERVICE.....</b>	<b>7</b>
<b>SAFETY.....</b>	<b>S</b>
<b>WIRING DIAGRAM.....</b>	<b>8</b>

# FOREWORD

This service manual includes general description, diagnosis, symptoms, and on-board service procedures for the fuel control and ignition systems used on GM equipped Marine Electronic Fuel Injection (MEFI) engines.

## INTRODUCTION

The following manual has been prepared for effective diagnosis of the Marine Electronic Fuel Injection (MEFI) system

All information, illustrations and specifications contained in this manual are based on the latest product information available at the time of publication approval. The right is reserved to make changes at any time without notice.

This manual should be kept in a handy place for ready reference. If properly used, it will meet the needs of technicians and boat owners.

## Safety Warning

Volvo Penta Workshop manuals are intended for use by professional, qualified technicians. Attempting repairs or service without the appropriate training, tools, and equipment could cause damage to the boat and could possibly result in personal injury to the operator and occupants.

### CAUTION

To reduce the chance of personal injury and/or property damage, the following instructions must be carefully observed.

Proper service and repair are important to the safety of the service technician and the safe, reliable operation of all Marine Electronic Fuel Injection (MEFI) equipped engines. If part replacement is necessary, the part must be replaced with one of the same part number or with an equivalent part. Do not use a replacement part of lesser quality.

The service procedures recommended and described in this service manual are effective methods of performing service and repair. Some of these procedures require the use of tools specifically designed for the purpose.

Accordingly, anyone who intends to use a replacement part, service procedure, or tool which is not recommended by the boat manufacturer, must first determine that neither his safety nor the safe operation of the boat will be jeopardized by the replacement part, service procedure, or tool selected.

It is important to note that this manual contains various Cautions and Notices that must be carefully observed in order to reduce the risk of personal injury during service or repair, or the possibility that improper service or repair may damage the boat or render it unsafe. It is also important to understand that these 'Cautions' and 'Notices' are not exhaustive, because it is impossible to warn of all the possible hazardous consequences that might result from failure to follow these instructions.

# MARINE ELECTRONIC FUEL INJECTION (MEFI)

## SECTION 1

# GENERAL INFORMATION

## CONTENTS

Visual/Physical Inspection . . . . .	Page-1	Normal Mode . . . . .	Page-5
Basic Knowledge and Tools		DLC Scan Tools . . . . .	Page-5
Required . . . . .	Page-1	MEFI On-Board Diagnostic (OBD)	
Electrostatic Discharge Damage . . . . .	Page-1	System Check . . . . .	Page-5
Diagnostic Information . . . . .	Page-1	Scan Tool Use With Intermittents . . . . .	Page-5
Wiring Harness Service . . . . .	Page-2	How Diagnostic Trouble Codes	
Wiring Connector Service . . . . .	Page-3	Are Set . . . . .	Page-6
Metri-Pack Series 150 Terminals . . . . .	Page-3	Clearing Diagnostic Trouble Codes	
Weather-Pack Connectors . . . . .	Page-3	(Non-Scan) . . . . .	Page-6
Engine Control Module (ECM)		Clearing Diagnostic Trouble Codes	
Self-Diagnostics . . . . .	Page-3	(Scan) . . . . .	Page 6
Malfunction Indicator Lamp (MIL) . . . . .	Page-4	Non-Scan Diagnostics of Driveability	
Intermittent Malfunction Indicator		Concerns (With No DTCs Set) . . . . .	Page-6
Lamp (MIL) . . . . .	Page-4	Tools Needed to Service the	
Reading Diagnostic Trouble Codes		System . . . . .	Page-7
(DTCs) . . . . .	Page-4	Special Tools (1 of 3) . . . . .	Page-8
Service Mode . . . . .	Page-5	Abbreviations . . . . .	Page-11

### VISUAL/PHYSICAL INSPECTION

**A careful visual and physical inspection must be performed as part of any diagnostic procedure. This can often lead to fixing a problem without further steps.** Inspect all vacuum hoses for correct routing, pinches, cuts, or disconnects. Be sure to inspect hoses that are difficult to see. Inspect all the wires in the engine compartment for proper connections, burned or chafed spots, pinched wires, or contact with sharp edges or hot exhaust manifolds. This visual/physical inspection is very important. It must be done carefully and thoroughly.

### BASIC KNOWLEDGE AND TOOLS REQUIRED

To use this manual most effectively, a general understanding of basic electrical circuits and circuit testing tools is required. You should be familiar with wiring diagrams, the meaning of voltage, ohms, amps, the basic theories of electricity, and understand what happens in an open or shorted wire.

To perform system diagnosis, several special tools and equipment are required. Please become acquainted with the tools and their use before attempting to diagnose the system. Special tools which are required for system service are illustrated at the end of this section.

### ELECTROSTATIC DISCHARGE DAMAGE

Electronic components used in control systems are often designed to carry very low voltage, and are very susceptible to damage caused by electrostatic discharge. It is possible for less than 100 volts of static electricity to cause damage to some electronic components. By comparison, it takes as much as 4,000 volts for a person to even feel the zap of a static discharge.

There are several ways for a person to become statically charged. The most common methods of charging are by friction and by induction. An example of charging by friction is a person sliding across a seat, in which a charge of as much as 25,000 volts can build up. Charging by induction occurs when a person with well insulated shoes stands near a highly charged object and momentarily touches ground. Charges of the same polarity are drained off, leaving the person highly charged with the opposite polarity. Static charges of either type can cause damage, therefore, it is important to use care when handling and testing electronic components.

### DIAGNOSTIC INFORMATION

The diagnostic charts and functional checks in this manual are designed to locate a faulty circuit or component through logic based on the process of elimination.

## 2- MEFI GENERAL INFORMATION

The charts are prepared with the requirement that the system functioned correctly at the time of assembly and that there are no multiple failures.

Engine control circuits contain many special design features not found in standard vehicle wiring. Environmental protection is used extensively to protect electrical contacts and proper splicing methods must be used when necessary.

The proper operation of low amperage input/output circuits depend upon good continuity between circuit connectors. It is important before component replacement and/or during normal troubleshooting procedures that a visual inspection of any questionable mating connector is performed. Mating surfaces should be properly formed, clean and likely to make proper contact. Some typical causes of connector problems are listed below.

1. Improperly formed contacts and/or connector housing.
2. Damaged contacts or housing due to improper engagement.
3. Corrosion, sealer or other contaminants on the contact mating surfaces.
4. Incomplete mating of the connector halves during initial assembly or during subsequent troubleshooting procedures.

5. Tendency for connectors to come apart due to vibration and/or temperature cycling.
6. Terminals not fully seated in the connector body.
7. Inadequate terminal crimps to the wire.

### WIRING HARNESS SERVICE

Wire harnesses should be replaced with proper part number harnesses. When signal wires are spliced into a harness, use the same gage wire with high temperature insulation only.

With the low current and voltage levels found in the system, it is important that the best possible bond be made at all wire splices by soldering the splices as shown in Figure 1.

Use care when probing a connector or replacing connector terminals. It is possible to short between opposite terminals. If this happens, certain components can be damaged. Always use jumper wires with the corresponding mating terminals between connectors for circuit checking. **NEVER** probe through connector seals, wire insulation, secondary ignition wires, boots, nipples or covers. Microscopic damage or holes may result in eventual water intrusion, corrosion and/or component or circuit failure.

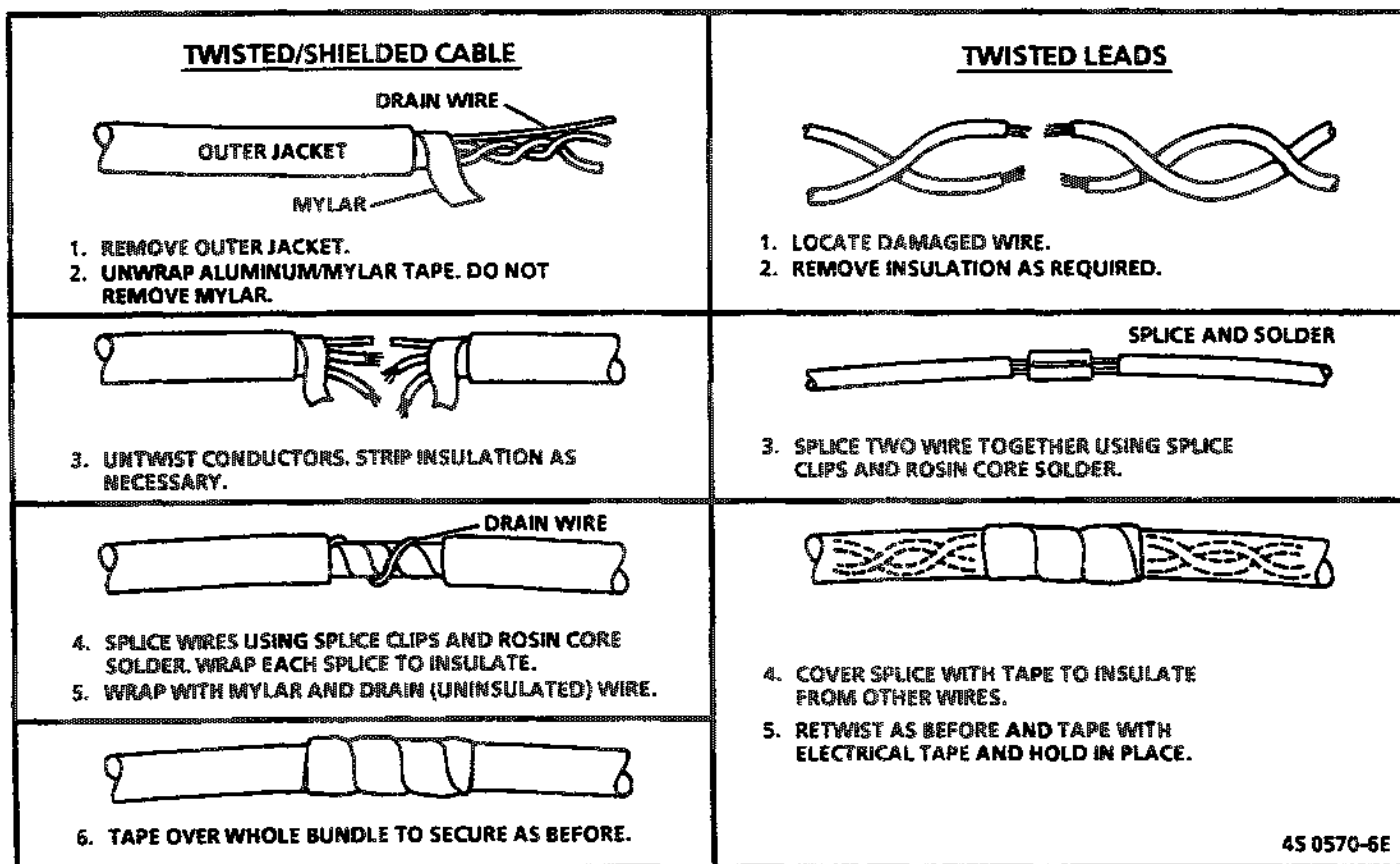

Figure 1 - Wiring Harness Repair



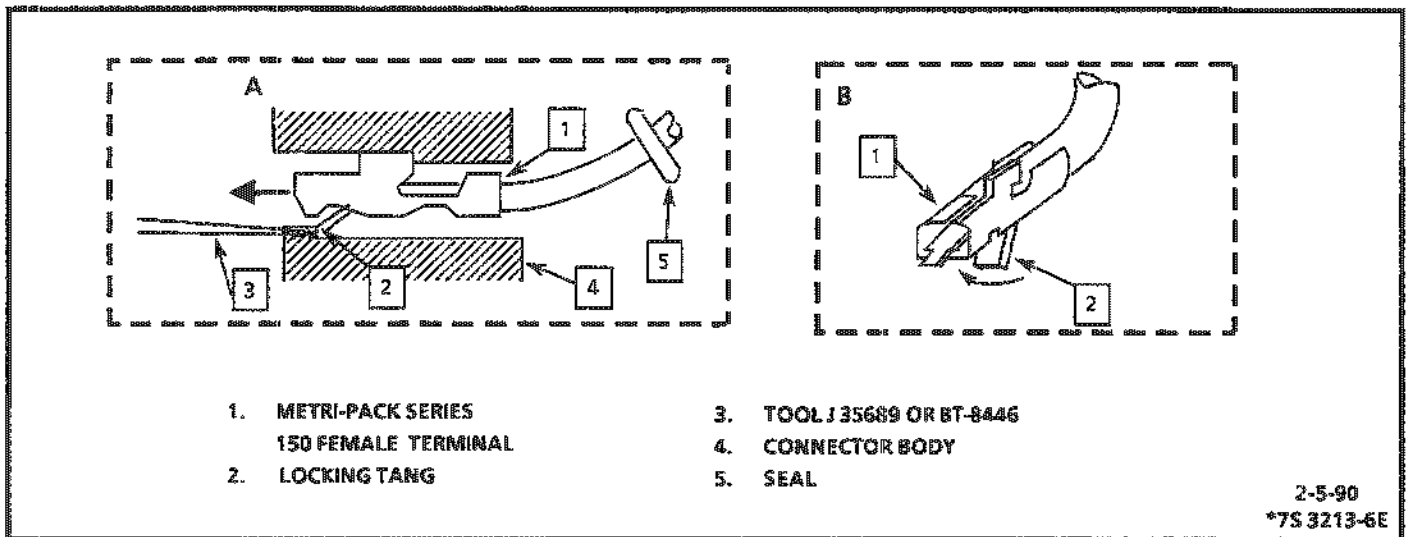

Figure 2 - Metri-Pack Series 150 Terminal Removal

## WIRING CONNECTOR SERVICE

Most connectors in the engine compartment are protected against moisture and dirt which could create oxidation and deposits on the terminals. This protection is important because of the very low voltage and current levels found in the electronic system. The connectors have a lock which secures the male and female terminals together. A secondary lock holds the seal and terminal into the connector.

When diagnosing, open circuits are often difficult to locate by sight because oxidation or terminal misalignment are hidden by the connectors. Merely wiggling a connector on a sensor or in the wiring harness may locate the open circuit condition. This should always be considered when an open circuit or failed sensor is indicated. Intermittent problems may also be caused by oxidized or loose connections.

Before making a connector repair, be certain of the type of connector. Some connectors look similar but are serviced differently. Replacement connectors and terminals are listed in the parts catalog.

### Metri-Pack Series 150 Terminals

Some ECM harness connectors contain terminals called Metri-Pack (Figure 2). These are used at some of the sensors and the distributor connector.

Metri-Pack terminals are also called "Pull-To-Seat" terminals because to install a terminal on a wire, the wire is first inserted through the seal (5) and connector (4). The terminal is then crimped on the wire, and the terminal pulled back into the connector to seat it in place.

To remove a terminal:

1. Slide the seal back on the wire.
2. Insert tool (3) BT-8518, J 35689, or equivalent as shown in insert "A" and "B" to release the terminal locking tang (2).

3. Push the wire and terminal out through the connector.

If the terminal is being reused, reshape the locking tang (2).

### Weather-Pack Connectors

Figure 3 shows a Weather-Pack connector and the tool (J 28742, BT-8234-A or equivalent) required to service it. This tool is used to remove the pin and sleeve terminals. If terminal removal is attempted without using the special tool required, there is a good chance that the terminal will be bent or deformed, and unlike standard blade type terminals, these terminals cannot be straightened once they are bent.

Make certain that the connectors are properly seated and all of the sealing rings in place when connecting leads. The hinge-type flap provides a secondary locking feature for the connector. It improves the connector reliability by retaining the terminals if the small terminal lock tangs are not positioned properly.

Weather-Pack connections cannot be replaced with standard connections. Instructions are provided with Weather-Pack connector and terminal packages.

## ENGINE CONTROL MODULE (ECM) SELF-DIAGNOSTICS

The Engine Control Module (ECM) performs a continual self-diagnosis on certain control functions. This diagnostic capability is complemented by the diagnostic procedures contained in this manual. The ECM's language for communicating the source of a malfunction is a system of Diagnostic Trouble Codes (DTCs). The DTCs are two digit numbers that can range from 12 to 51. When a malfunction is detected by the ECM, a DTC is set and the malfunction indicator lamp is illuminated.

## 4- MEFI GENERAL INFORMATION

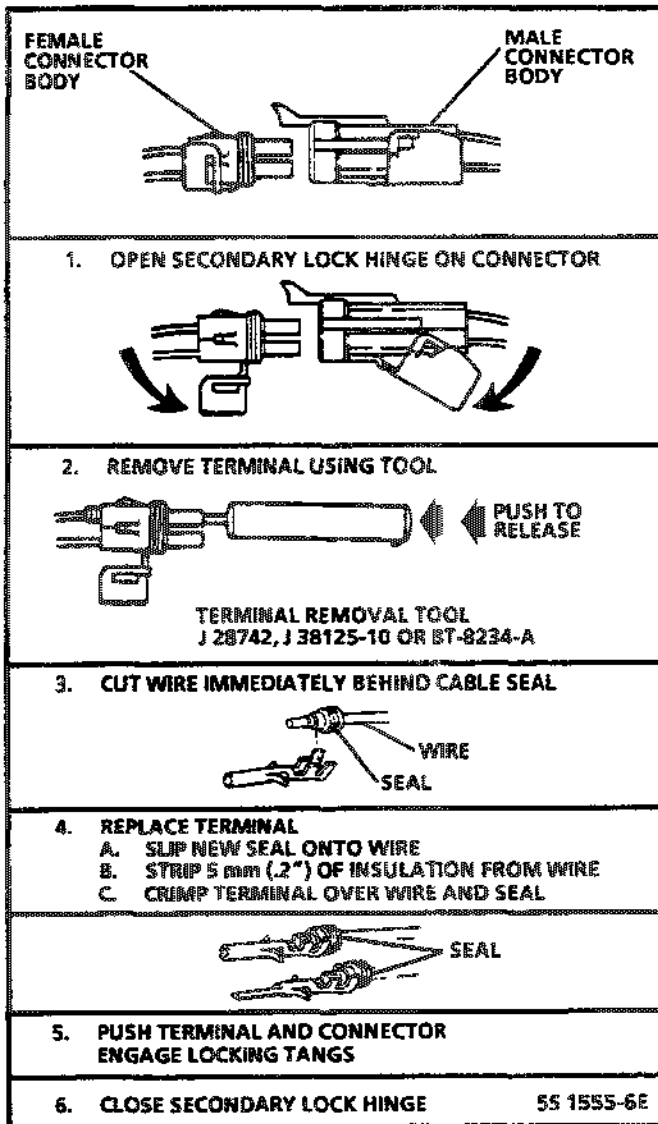

Figure 3 - Weather-Pack Terminal Repair

### MALFUNCTION INDICATOR LAMP (MIL)

The malfunction indicator lamp is part of the Marine Diagnostic Trouble Code (MDTC) tool (TA-06075), or it can be a dash mounted warning light on some boat models.

- If present it informs the operator that a problem has occurred and that the boat should be taken for service as soon as reasonably possible.
- It displays DTCs stored by the ECM which help the technician diagnose system problems.

As a bulb and system check, the light will come "ON" with the key "ON" and the engine not running. When the engine is started, the light will turn "OFF." If the light remains "ON," the self-diagnostic system has detected a problem. If the problem goes away, the light will go out in most cases after 10 seconds, but a DTC will remain stored in the ECM.

When the light remains "ON" while the engine is running, or when a malfunction is suspected due to a driveability problem, "MEFI On-Board Diagnostic

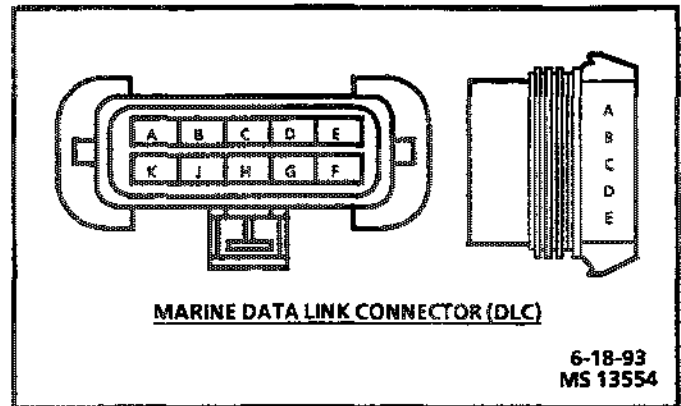

Figure 4 - Marine DLC

(OBD) System Check" must be performed. These checks will expose malfunctions which may not be detected if other diagnostics are performed prematurely.

### Intermittent Malfunction Indicator Lamp (MIL)

In the case of an "intermittent" problem, the malfunction indicator lamp will light for ten (10) seconds and then will go out. However, the corresponding Diagnostic Trouble Code (DTC) will be stored in the memory of the ECM. When DTCs are set by an intermittent malfunction they could be helpful in diagnosing the system.

An intermittent DTC if cleared may or may not reset. If it is an intermittent failure, consult the "Diagnostic Aids" on the page facing the DTC chart corresponding to the intermittent DTC. "Symptoms" also covers the topic of "Intermittents." A physical inspection of the applicable sub-system most often will resolve the problem.

### Reading Diagnostic Trouble Codes (DTCs)

The provision for communicating with the ECM is the Data Link Connector (DLC) (See Figure 4). It is part of the MEFI engine wiring harness, and is a 10 pin connector, which is electrically connected to the ECM. It is used in the assembly plant to receive information in checking that the engine is operating properly before it leaves the plant. The DTC(s) stored in the ECM's memory can be read either through scan tool, a hand-held diagnostic scanner plugged into the DLC or by counting the number of flashes of the MIL when the marine diagnostic trouble code tool is installed and "Service" mode is selected.

Once the marine diagnostic trouble code tool has been connected, the ignition switch must be moved to the "ON" position, with the engine not running. At this point, the MIL should flash DTC 12 three times consecutively.

This would be the following flash sequence: "flash, pause, flash-flash, long pause, flash, pause, flash-flash, long pause, flash, pause, flash-flash." DTC 12 indicates that the ECM's diagnostic system is operating. If DTC 12 is not indicated, a problem is present within the diagnostic system itself, and should be addressed by consulting the appropriate diagnostic chart in the "Diagnosis" section.

Following the output of DTC 12, the MIL will indicate a DTC three times if a DTC is present, or it will simply continue to output DTC 12. If more than one DTC has been stored in the ECM's memory, the DTCs will be output from the lowest to the highest, with each DTC being displayed three times.

### Service Mode

When the marine diagnostic trouble code tool is installed at the DLC and the switch is selected to "Service," the system will enter what is called the Service Mode. In this mode the ECM will:

1. Display a DTC 12 by flashing the MIL (indicating the system is operating correctly).
2. Display any stored DTCs by flashing the MIL. Each DTC will be flashed three times, then DTC 12 will be flashed again.
3. The ignition timing is controlled to a fixed timing degree programmed in the ECM. This will allow base timing to be adjusted on distributor ignition engines.
4. The IAC valve moves to its fully extended position on most models, blocking the idle air passage. This is important to remember, as an attempt to run the boat while in "Service" mode will most likely result in an abnormally low idle speed.

### Normal Mode

The normal mode will have no effect on engine operation.

### DLC SCAN TOOLS

The ECM can communicate a variety of information through the DLC. This data is transmitted at a high frequency which requires a scan tool for interpretation.

With an understanding of the data which the scan tool displays, and knowledge of the circuits involved, the scan tool can be very useful in obtaining information which would be more difficult or impossible to obtain with other equipment.

A scan tool does not make the use of diagnostic charts unnecessary, nor can they indicate exactly where a problem is in a particular circuit. Tree charts incorporate diagnosis procedures using a scan tool

where possible or a marine diagnostic trouble code tool (non-scan) if a scan tool is unavailable.

### MEFI ON-BOARD DIAGNOSTIC (OBD) SYSTEM CHECK

After the visual/physical inspection, the "On-Board Diagnostic System Check" is the starting point for all diagnostic procedures. Refer to "Diagnosis" section.

The correct procedure to diagnose a problem is to follow two basic steps.

1. Are the on-board diagnostics working? This is determined by performing the "On-Board Diagnostic (OBD) System Check." Since this is the starting point for the diagnostic procedures, always begin here. If the on-board diagnostics aren't working, the OBD system check will lead to a diagnostic chart in "Diagnosis" section to correct the problem. If the on-board diagnostics are working correctly, the next step is:
2. Is there a DTC stored? If a DTC is stored, go directly to the numbered DTC chart in "Diagnosis" section. This will determine if the fault is still present.

### SCAN TOOL USE WITH INTERMITTENTS

The scan tool provides the ability to check, (wiggle test) of wiring harnesses or components with the engine not running, while observing the scan tool readout.

The scan tool can be plugged in and observed while driving the boat under the condition when the MIL turns "ON" momentarily or when the engine driveability is momentarily poor. If the problem seems to be related to certain parameters that can be checked on the scan tool, they should be checked while driving the boat. If there does not seem to be any correlation between the problem and any specific circuit, the scan tool can be checked on each position, watching for a period of time to see if there is any change in the readings that indicates intermittent operation.

The scan tool is also an easy way to compare the operating parameters of a poorly operating engine with those of a known good one. For example, a sensor may shift in value but not set a diagnostic trouble code. Comparing the sensor's readings, with those of the typical scan tool data readings, may uncover the problem.

The scan tool has the ability to save time in diagnosis and prevent the replacement of good parts. The key to using the scan tool successfully for diagnosis lies in the technician's ability to understand the system he is trying to diagnose as well as an understanding of the scan tool operation and limitations.

## 6- MEFI GENERAL INFORMATION

The technician should read the tool manufacturer's operating manual to become familiar with the tool's operation.

### HOW DIAGNOSTIC TROUBLE CODES ARE SET

The ECM is programmed to receive calibrated voltage signals from the sensors. The voltage signal from the sensor may range from as low as .1 volt to as high as 4.9 volts. The sensor voltage signal is calibrated for engine application. This would be the sensor's working parameter or "window." The ECM and sensors will be discussed further in the "ECM and Sensor" section.

If a sensor is within its working or acceptable parameters (Figure 5), the ECM does not detect a problem. When a sensor voltage signal falls out of this "window," or an open or short occurs in the wiring to the sensor, the ECM would not receive the "window" voltage for that sensor. When the ECM does not receive the "window" voltage for a programmed length of time a DTC will be stored. The MIL will be illuminated and a known default value will replace the sensed value to restore engine performance.

### CLEARING DIAGNOSTIC TROUBLE CODES (NON-SCAN)

1. Install Marine Diagnostic Trouble Code (MDTC) tool.
2. Turn ignition switch to "ON," engine not running.
3. Select "Service" mode on MDTC tool.
4. Move the throttle from 0% (idle) to 100% (WOT) and back to 0%.
5. Select "Normal" mode on MDTC tool. (If this step is not performed, the engine may not start and run.)
6. Start engine and run for at least 20 seconds.
7. Turn ignition switch to "OFF" for at least 20 seconds.
8. Turn ignition switch to "ON." Engine not running.
9. Select "Service" mode on the MDTC tool and verify DTC 12 only. Remove MDTC tool.
10. If original DTCs are still present, check "Notice" below and repeat the DTC clearing procedure.
11. If new DTCs are displayed, perform On-Board Diagnostic (OBD) system check.

**NOTICE:** When clearing DTCs without the use of a scan tool, the battery must be fully charged and cranking speed must be at least 200 RPM. The ability to clear DTCs is directly dependent on battery being fully charged and able to crank engine with adequate cranking RPM.

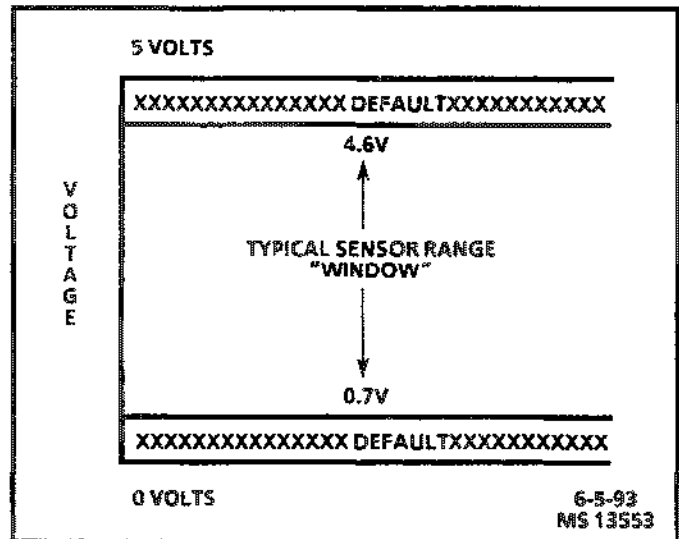

Figure 5 - Example of Sensor Normal Operation

### CLEARING DIAGNOSTIC TROUBLE CODES (SCAN)

1. Install scan tool.
2. Start engine.
3. Select clear DTCs function.
4. Clear DTCs.
5. Turn ignition "OFF" for 20 seconds.
6. Turn ignition "ON" and read DTCs. If DTCs are still present, check "Notice" below and repeat following from Step 2.

**NOTICE:** When clearing DTCs with the use of a scan tool, the battery must be fully charged and cranking speed must be at least 200 RPM. The ability to clear DTCs is directly dependent on battery being fully charged and able to start engine with adequate cranking RPM.

A poorly charged battery or engine cranking problem may result in an ECM "reset" and may not allow stored DTCs to be cleared from EEPROM memory.

If this condition exists, be sure battery is fully charged and repair charging/starting system before attempting to clear DTCs from memory.

### NON-SCAN DIAGNOSIS OF DRIVEABILITY CONCERNS (WITH NO DTCs SET)

If a driveability concern still exists after following the diagnostic circuit check and reviewing the "Symptoms" section, an out of range sensor may be suspected. Because of the unique design of the MEFI system, fail safes have been programmed into the ECM to replace a sensed value with a default value in the case of a sensor malfunction or sensor wiring concern. By allowing this to occur, limited engine performance is restored until the vehicle is repaired.

A basic understanding of sensor operation is necessary to be able to diagnose an out of range sensor.

If the sensor is out of range, but still within the operating "Window" of the ECM, the problem will go undetected by the ECM and may result in a driveability concern.

A good example of this would be if the coolant sensor was reading incorrectly and indicating to the ECM that coolant temperature was at 50°F, but actual coolant temperature was 150°F (Figure 6). This would cause the ECM to deliver more fuel than was actually needed and result in an overly rich, rough running condition. This condition would not have caused a DTC to set as the ECM interprets this as within it's "Range."

To identify a sensor which is out of range, you may unplug it while running the engine. After approximately 2 minutes, the DTC for that sensor will set, illuminate the MIL, and replace the sensed value with a default value. If at that point a noticeable performance increase is observed, the non-scan DTC chart for that particular sensor should be followed to correct the problem.

**NOTICE:** Be sure to clear each DTC after disconnecting and reconnecting each sensor. Failure to do so may result in a mis-diagnosis of the driveability concern.

## TOOLS NEEDED TO SERVICE THE SYSTEM

The system requires a scan tool or Marine Diagnostic Trouble Code (MDTC) tool, inductive pick-up timing light, fuel pressure test gauge, tachometer, test light, digital volt ohmmeter with a minimum of 10 megohms impedance (J 34029-A or equivalent), vacuum pump with gage and jumper wires for diagnosis. A test light or DVOM must be used when specified in the procedures. See the end of this section for special tools needed to diagnose or repair a system. For more complete information on the operation of these tools, consult the tool manufacturer's instructions.

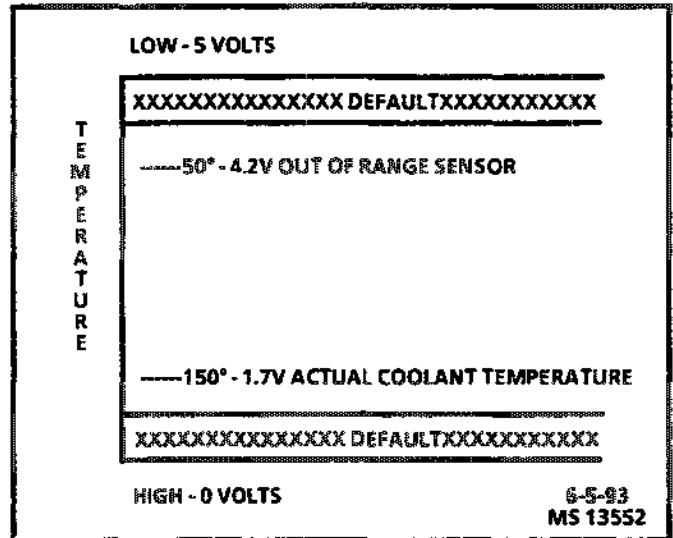

Figure 6 - Example of Shifted Sensor Operation



 <p><b>HIGH IMPEDANCE MULTIMETER (DIGITAL VOLT-OHMMETER-DVOM)</b></p> <p>J 34029-A</p>	<p><b>VOLTMETER</b> - Voltage position measures magnitude of voltage when connected in parallel to an existing circuit. A digital voltmeter with a 10 megohm input impedance is used because this type of meter will not load down the circuit and result in faulty readings. Some circuits require accurate low voltage readings because they have a very high resistance.</p> <p><b>AMMETER</b> - When used as an ammeter, this meter accurately measures extremely low current flow. Refer to meter instructions for more information.</p> <ul style="list-style-type: none"> <li>● Selector must be set properly for both function and range. DC is used for most measurements.</li> </ul> <p><b>OHMMETER</b> - Measures resistance of circuit directly in ohms. Refer to meter instructions for more information.</p> <ul style="list-style-type: none"> <li>● OL display in all ranges indicates open circuit.</li> <li>● Zero display in all ranges indicates a short circuit.</li> <li>● An intermittent connection in a circuit may be indicated by a digital reading that will not stabilize on the circuit.</li> <li>● Range Switch - Automatic and Manual.             <ul style="list-style-type: none"> <li>200Ω - Reads ohms directly</li> <li>2K, 20K, 200KΩ - Reads ohms in thousands</li> <li>2M, 20MΩ, 200MΩ - Reads ohms in millions</li> </ul> </li> </ul>
 <p>J 23738-A</p>	<p><b>VACUUM PUMP WITH GAGE (20 IN. HG. MINIMUM)</b> Use the gage to monitor manifold engine vacuum and use the hand pump to check vacuum sensors, solenoids and valves.</p>
 <p>J 34142-B</p>	<p><b>UNPOWERED TEST LIGHT</b> Used for checking wiring for complete circuit, short to ground, or voltage.</p>
	<p><b>TACHOMETER</b> Must have inductive trigger signal pick-up.</p>

Figure 7 - Special Tools (1 of 3)





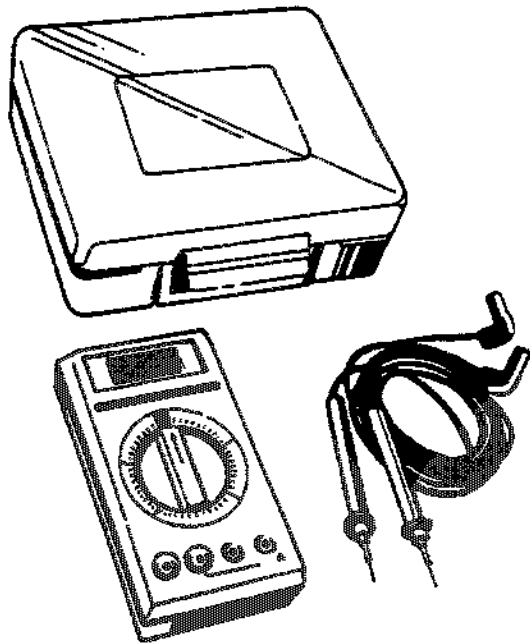
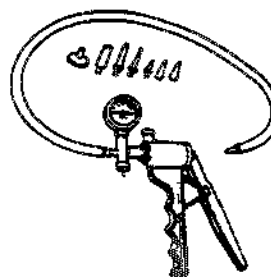
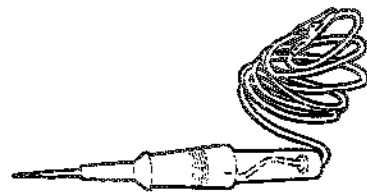

 <p>J 35689</p>	<p><b>METRI-PACK TERMINAL REMOVER</b> Used for removing 150 series Metri-Pack "pull-to-seat" terminals from connectors. Refer to wiring harness service in MEFI General Information Section for removal procedure.</p>
 <p>J 28742-A/BT-8234-A</p>	<p><b>WEATHER PACK TERMINAL REMOVER</b> Used for removing terminals from Weather Pack connectors. Refer to wiring harness service in MEFI General Information Section for removal procedure.</p>
 <p>TA 06075</p>	<p><b>MARINE DIAGNOSTIC TROUBLE CODE (MDTC) TOOL</b> A hand held diagnostic tool that is used to diagnose fuel and emission systems. It will flash a code when a problem is detected.</p>
 <p>J 29658-D</p>	<p><b>FUEL PRESSURE GAUGE</b> Used for checking fuel system pressure on TBI engines.</p>
 <p>J 34730-1A</p>	<p><b>FUEL PRESSURE GAUGE</b> Used for checking fuel pump pressure on MFI engines.</p>
 <p>J 34730-2C &amp; J 34730-350/BT 8329</p>	<p><b>INJECTOR HARNESS TEST LIGHT</b> A specially designed light used to visually indicate injector electrical impulses from the ECM.</p>
 <p>TK 00450</p>	<p><b>TECH 1 SCAN TOOL (Optional)</b> A hand held diagnostic tool that is used to diagnose fuel and emission systems. It will display various parameters. (A cartridge is required: TK 01940.)</p>

Figure 8 - Special Tools (2 of 3)

10- MEFI GENERAL INFORMATION

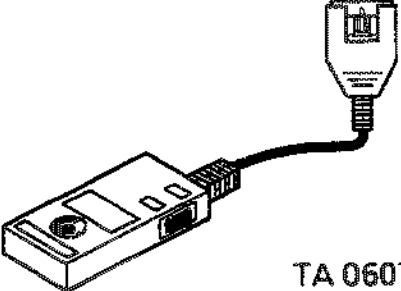
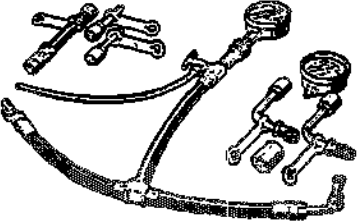
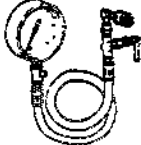
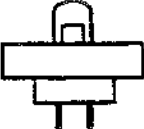
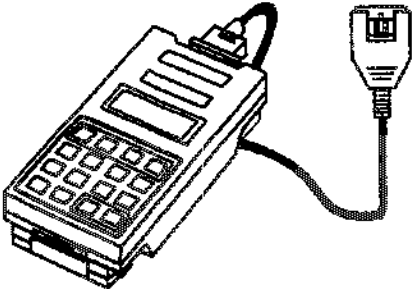
 <p>J 33031</p>	<p><b>IDLE AIR CONTROL (IAC) WRENCH</b> Used for removing and installing the thread mounted IAC valve on the throttle body.</p>
 <p>J 35632/BT-8514A</p>	<p><b>IDLE AIR CONTROL REMOVER</b> Used to remove idle air control assembly on port fuel injection engine.</p>
 <p>J 35616</p>	<p><b>HARNESS TEST ADAPTER KIT</b> Used to make electrical test connections in current Weather Pack, Metri-Pack, and Micro-Pack style terminals.</p>
 <p>TA 06076</p>	<p><b>20' DIAGNOSTIC CONNECTOR EXTENSION CABLE</b> Extension cable to go between the "Tech 1" and the DLC on the engine harness.</p>
 <p>J 37088-A/BT-9171</p>	<p><b>FUEL LINE QUICK-CONNECT SEPARATOR</b> Used to release fuel line quick-connect fittings.</p>
 <p>J 39021</p>	<p><b>INJECTOR TESTER</b> Separately energized each injector to compare for equal impulses over a constant time interval.</p>
	<p><b>TIMING LIGHT</b> Must have inductive signal pickup.</p>

7-6-93  
MS 13617

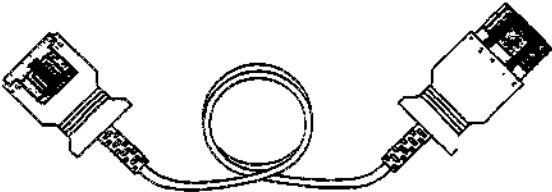
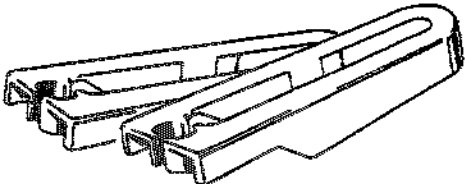
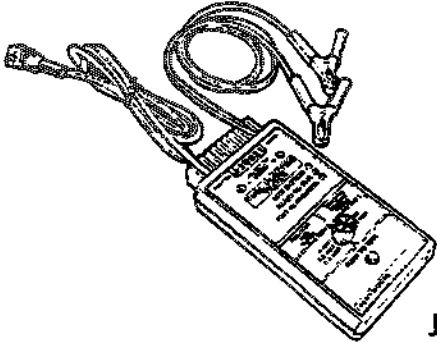
Figure 9 - Special Tools (3 of 3)



## ABBREVIATIONS

<b>BARO</b>	-	<b>BAROMETRIC PRESSURE</b>
<b>BAT</b>	-	<b>BATTERY, BATTERY POSITIVE TERMINAL, BATTERY OR SYSTEM VOLTAGE</b>
<b>B +</b>	-	<b>BATTERY POSITIVE</b>
<b>CKP</b>	-	<b>CRANKSHAFT POSITION SENSOR</b>
<b>CKT</b>	-	<b>CIRCUIT</b>
<b>CMFI</b>	-	<b>CENTRAL MULTIPOINT FUEL INJECTION</b>
<b>CONN</b>	-	<b>CONNECTOR</b>
<b>CYL</b>	-	<b>CYLINDER</b>
<b>DEG</b>	-	<b>DEGREES</b>
<b>DI</b>	-	<b>DISTRIBUTOR IGNITION</b>
<b>DIAG</b>	-	<b>DIAGNOSTIC</b>
<b>DIST</b>	-	<b>DISTRIBUTOR</b>
<b>DLC</b>	-	<b>DATA LINK CONNECTOR</b>
<b>DTC</b>	-	<b>DIAGNOSTIC TROUBLE CODE</b>
<b>DVOM</b>	-	<b>DIGITAL VOLT OHMMETER</b>
<b>ECM</b>	-	<b>ENGINE CONTROL MODULE</b>
<b>ECT</b>	-	<b>ENGINE COOLANT TEMPERATURE SENSOR</b>
<b>EEPROM</b>	-	<b>ELECTRONIC ERASABLE PROGRAMMABLE READ ONLY MEMORY</b>
<b>EI</b>	-	<b>ELECTRONIC IGNITION</b>
<b>EMI</b>	-	<b>ELECTROMAGNETIC INTERFERENCE</b>
<b>ENG</b>	-	<b>ENGINE</b>
<b>E-STOP</b>	-	<b>EMERGENCY STOP</b>
<b>GND</b>	-	<b>GROUND</b>
<b>GPH</b>	-	<b>GALLONS PER HOUR</b>
<b>IAC</b>	-	<b>IDLE AIR CONTROL</b>
<b>IAT</b>	-	<b>INTAKE AIR TEMPERATURE</b>
<b>IC</b>	-	<b>IGNITION CONTROL</b>
<b>IGN</b>	-	<b>IGNITION</b>
<b>INJ</b>	-	<b>INJECTOR</b>
<b>I/O</b>	-	<b>INPUT/OUTPUT</b>
<b>kPa</b>	-	<b>KILOPASCAL</b>
<b>KS</b>	-	<b>KNOCK SENSOR SYSTEM</b>
<b>KV</b>	-	<b>KILOVOLTS</b>
<b>MAP</b>	-	<b>MANIFOLD ABSOLUTE PRESSURE</b>
<b>MDTC</b>	-	<b>MARINE DIAGNOSTIC TROUBLE CODE TOOL</b>
<b>MEFI</b>	-	<b>MARINE ELECTRONIC FUEL INJECTION</b>
<b>MFI</b>	-	<b>MULTIPOINT FUEL INJECTION</b>
<b>MIL</b>	-	<b>MALFUNCTION INDICATOR LAMP</b>
<b>MSEC</b>	-	<b>MILLSECOND</b>
<b>N/C</b>	-	<b>NORMALLY CLOSED</b>
<b>N/O</b>	-	<b>NORMALLY OPEN</b>
<b>OBD</b>	-	<b>ON-BOARD DIAGNOSTIC SYSTEM CHECK</b>
<b>OPT</b>	-	<b>OPTIONAL</b>
<b>PROM</b>	-	<b>PROGRAMMABLE READ ONLY MEMORY</b>
<b>PWM</b>	-	<b>PULSE WIDTH MODULATION</b>
<b>RAM</b>	-	<b>RANDOM ACCESS MEMORY</b>
<b>REF HI</b>	-	<b>REFERENCE HIGH</b>
<b>REF LO</b>	-	<b>REFERENCE LOW</b>
<b>ROM</b>	-	<b>READ ONLY MEMORY</b>
<b>SLV</b>	-	<b>SLAVE</b>

## ABBREVIATIONS (CONT)

SW	- SWITCH
TACH	- TACHOMETER
TBI	- THROTTLE BODY INJECTION
TERM	- TERMINAL
TP	- THROTTLE POSITION SENSOR
V	- VOLTS
VAC	- VACUUM
WOT	- WIDE OPEN THROTTLE
" HG	- INCHES OF MERCURY

# MARINE ELECTRONIC FUEL INJECTION (MEFI)

## SECTION 2

# ENGINE CONTROL MODULE (ECM) AND SENSORS

## CONTENTS

General Description .....	Page-1	Density .....	Page-3
Computers and Voltage Signals .....	Page-1	ECM Inputs and Sensor Descriptions .....	Page-3
Analog Signals .....	Page-1	MEFI Inputs and Outputs .....	Page-4
Three-Wire Sensors .....	Page-1	Engine Coolant Temperature (ECT) Sensor .....	Page-5
Two-Wire Sensors .....	Page-2	Manifold Absolute Pressure (MAP) Sensor .....	Page-5
Digital Signals .....	Page-2	Knock Sensor .....	Page-5
Switch Types .....	Page-2	Knock Sensor (KS) Module .....	Page-6
Pulse Counters .....	Page-2	Throttle Position (TP) Sensor .....	Page-6
Engine Control Module (ECM) .....	Page-2	Intake Air Temperature (IAT) Sensor (Big Block Only) .....	Page-7
ECM Function .....	Page-2	Ignition Control (IC) Reference .....	Page-7
Memory .....	Page-3	Trim Position Sensor (Optional) .....	Page-7
ROM .....	Page-3	Discrete Switch Inputs (Optional) .....	Page-7
RAM .....	Page-3		
EEPROM .....	Page-3		
Speed Density System .....	Page-3		
Speed .....	Page-3		

## GENERAL DESCRIPTION

The Marine Electronic Fuel Injection (MEFI) system is equipped with a computer that provides the operator with state-of-the-art control of fuel and spark delivery. Before we discuss the computers on the Marine applications, let's discuss how computers use voltage to send and receive information.

## COMPUTERS AND VOLTAGE SIGNALS

Voltage is electrical pressure. Voltage does not flow thru circuits. Instead, voltage causes current. Current does the real work in electrical circuits. It is current, the flow of electrically charged particles, that energizes solenoids, closes relays and lights lamps.

Besides causing currents in circuits, voltage can be used as a signal. Voltage signals can send information by changing levels, changing waveform (shape), or changing the speed at which the signal switches from one level to another. Computers use voltage signals to communicate with one another. The different sections inside computers also use voltage signals to talk to each other.

There are two kinds of voltage signals, analog and digital. Both of these are used in computer systems. It's important to understand the difference between them and the different ways they are used.

## ANALOG SIGNALS

An analog signal is continuously variable. This means that the signal can be any voltage within a certain range.

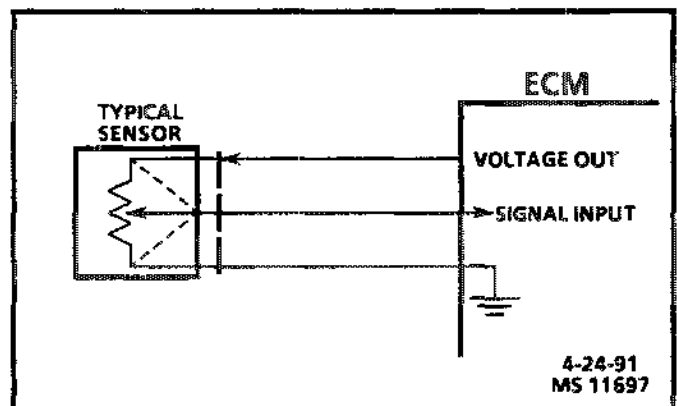

Figure 1 - Three Wire Sensors

An analog signal usually gives information about a condition that changes continuously over a certain range. For example, in a Marine engine, temperature is usually provided by an analog signal. There are two general types of sensors that produce analog signals; the 3-wire and the 2-wire sensor.

## Three-Wire Sensors

Figure 1 shows a schematic representation of a 3-wire sensor. All 3-wire sensors have a reference voltage, a ground and a variable "wiper." The lead coming off of the "wiper" will be the signal to the Engine Control Module (ECM). As this wiper position changes, the signal voltage returned to the computer also changes.

## 2- MEFI ENGINE CONTROL MODULE (ECM) AND SENSORS

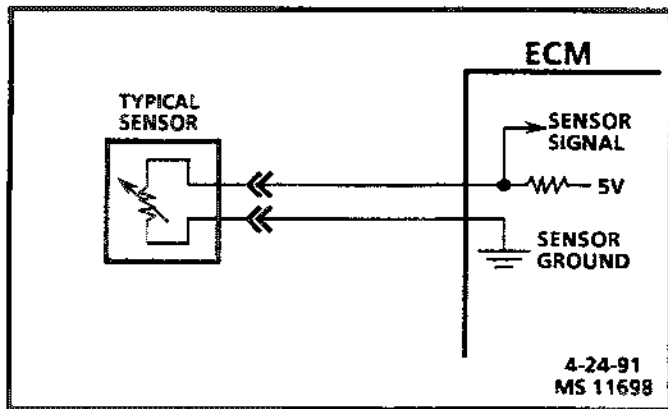

Figure 2 - Two Wire Sensors

### Two-Wire Sensors

Figure 2 is the schematic of a 2-wire type sensor. This sensor is basically a variable resistor in series with a fixed-known resistor within the computer. By knowing the values of the input voltage and the voltage drop across the known resistor, the value of the variable resistor can be determined. The variable resistors that are commonly used are called thermistors. A thermistor's resistance varies with temperature.

### DIGITAL SIGNALS

Digital signals are also variable, but not continuously. They can only be represented by distinct voltages within a range. For example, 1V, 2V or 3V would be allowed, but 1.27V or 2.65V would not. Digital signals are especially useful when the information can only refer to two conditions - "YES" and "NO," "ON" and "OFF," or "High" and "Low." This would be called a digital binary signal. A digital binary signal is limited to two voltage levels. One level is a positive voltage, the other is no voltage (zero volts). As you can see in Figure 3, a digital binary signal is a square wave.

The computer uses digital signals in a code that contains only ones and zeros. The high voltage of the digital signal represents a one (1), and no voltage represents a zero (0). Each zero and each one is called a bit of information, or just a "bit." Eight bits together are called a "word." A word, therefore, contains some combination of eight binary code bits: eight ones, eight zeros, five ones and three zeros, and so on.

Binary code is used inside a computer and between a computer and any electronic device that understands the code. By stringing together thousands of bits, computers can communicate and store an infinite variety of information. To a computer that understands binary, 11001011 might mean that it should turn an output device "ON" at a slow speed. Although the computer uses 8-bit digital codes internally and when talking to another computer, each bit can have a meaning.

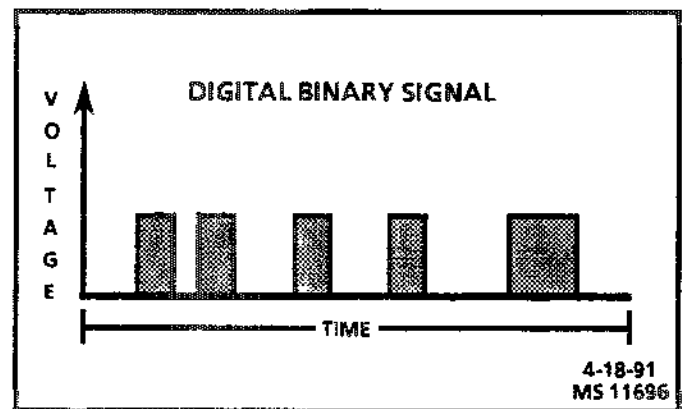

Figure 3 - Digital Voltage Signal

### Switch Types

Switched inputs (also known as discretives) to the computer can cause one bit to change, resulting in information being communicated to the computer. Switched inputs can come in two types; they are "pull-up" and "pull-down" types. Both types will be discussed.

With a "pull-up" type switch, the ECM will sense a voltage when the switch is CLOSED. In the case of the "pull-down," the ECM "sees" the voltage when the switch is OPEN.

### Pulse Counters

For the computer to determine frequency information from a switched input, the computer must measure the time between voltage pulses. As a number of pulses are recorded in a set amount of time, the computer can calculate the frequency. The meaning of the frequency number can have any number of meanings to the computer.

An example of a pulse counter type of input is the distributor reference pulse input. The computer can count a train of pulses, a given number of pulses per engine revolution. In this way, the computer can determine the RPM of the engine.

### ENGINE CONTROL MODULE (ECM)

The Engine Control Module (ECM) (Figure 4) is the control center of the fuel injection system. It constantly monitors information from various sensors, and controls the systems that affect vehicle performance.

The ECM also performs a diagnostic function check of the system. It can recognize operational problems and store a Diagnostic Trouble Code(s) which identify the problem areas to aid the technician in making repairs.

### ECM Function

The ECM supplies 5 or 12 volts to power various sensors or switches.